

## Light control for a classroom

Light management system LiveLink with DALI control gear units and luminaire-integrated sensor in Use Case "Classroom".

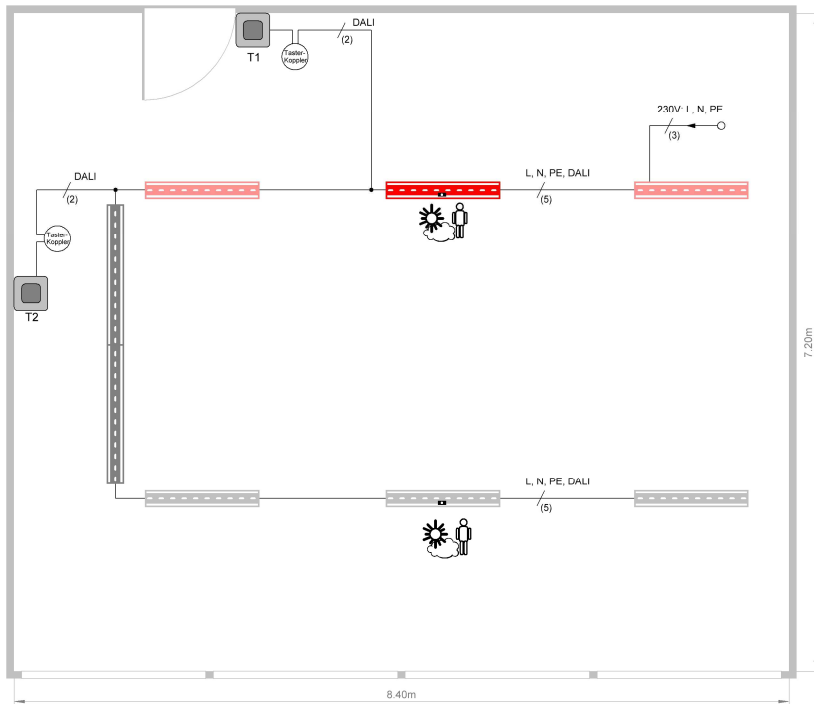

- Daylight-dependent individual control of room lighting, board lighting uncontrolled
- Presence detection of all luminaire groups in semi-automatic operation
- Room lighting control through one push button ON/OFF/DIM switching between semi-automatic and manual operation
- Push button control for board lighting ON/OFF/DIM without daylight control
- Addressing of lighting via iOS or Android tablet

### Use Case "Classroom"

The installation of LiveLink starts with conventional DALI wiring: The components – luminaires, sensors and push buttons – are connected to the control unit via DALI. Control unit and luminaires also require a standard mains connection. It is important to observe that DALI wiring must be configured in a way suited to mains voltage. DALI wiring may run in a mains-powered wire (NYM-J 5 x 1.5mm<sup>2</sup>).

In the Use Case "Classroom", the luminaire groups "Board", "Window" and "Corridor (+ Centre)" are preset. Additionally, there are two sensors in charge of daylight-dependent light control and presence detection per group.

General information on Use Cases:

Use Cases should be updated regularly on your tablet in the LiveLink Install App. Use Cases can be updated in the LiveLink Install App in the menu item "Use Case Management".

Preset luminaire groups		Preset scenes	
Luminaire Group	Function	Scene	Function
Board	<ul style="list-style-type: none"> <li>• Presence detection</li> </ul>	Automatic	<ul style="list-style-type: none"> <li>• 10 minutes switch-off delay, semi-automatic operation for all groups</li> <li>• Individualised daylight-dependent control for the groups "Window" [S1] and "Corridor" [S2]</li> </ul>
Window	<ul style="list-style-type: none"> <li>• Presence detection</li> <li>• Daylight-dependent control</li> </ul>	Projection	<ul style="list-style-type: none"> <li>• Constant dimming levels for the following groups: <ul style="list-style-type: none"> <li>• Board 0 %</li> <li>• Window 20 %</li> <li>• Corridor 20 %</li> </ul> </li> <li>• 5 minutes switch-off delay</li> </ul>
Corridor (+ Centre)	<ul style="list-style-type: none"> <li>• Presence detection</li> <li>• Daylight-dependent control</li> </ul>	Service	<ul style="list-style-type: none"> <li>• Constant dimming level for all groups at 100 %</li> <li>• 10 minutes switch-off delay</li> </ul>
		Night lighting	<ul style="list-style-type: none"> <li>• Constant dimming level for all groups at 20 %</li> <li>• No automatic switch-off</li> </ul>
		Off	<ul style="list-style-type: none"> <li>• All groups off</li> </ul>

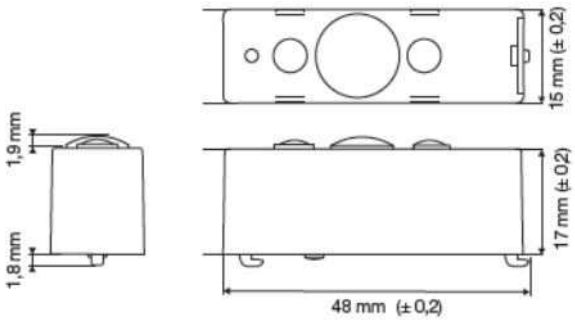

Sensor LD/PD LI	
<b>Technical data</b>	
Characteristics	<ul style="list-style-type: none"><li>• Compact construction for luminaire integration or alternatively ceiling recessing</li><li>• Available integrated in LiveLink master luminaire on request</li></ul>
Sensor type	<ul style="list-style-type: none"><li>• Passive infrared presence sensor (PIR)</li><li>• Light sensor</li></ul>
Dimensions	
Place of operation	<ul style="list-style-type: none"><li>• Indoor</li></ul>
Light value setting	<ul style="list-style-type: none"><li>• 20 - 800 lx</li></ul>
Protection rating	<ul style="list-style-type: none"><li>• IP20 (IP54 with AP box)</li></ul>
Safety class	<ul style="list-style-type: none"><li>• II</li></ul>
Temperature range	<ul style="list-style-type: none"><li>• -20°C to +50°C</li></ul>
Number of DALI devices	<ul style="list-style-type: none"><li>• 2</li></ul>
Mounting height (ceiling mounting)	<ul style="list-style-type: none"><li>• 2m – 5m</li></ul>
Detection angle/square	<ul style="list-style-type: none"><li>• max. diameter 7 m</li></ul>



## Sensor placement

### **Detection range**

- The sensor's detection range must be considered (see sensor product specification sheet). The sensor should cover working and movement areas in the room, but also – if possible – the entrance, so that the light can be switched on in good time. If the detection range is insufficient, a greater number of sensors must be arranged.
- When using high-frequency or radar sensors, it is important to consider that detection may occur even through thin walls. Furthermore, the narrow detection range (see product specification sheet) must be considered.

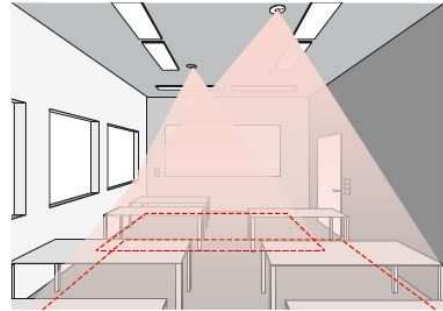

### **Light sensor**

For daylight control functions it is important that the light or combined presence and light sensor is placed in a suitable position.

- The light sensor should not be placed too close to window surfaces, but also not too far inside the room.
- The sensor should be placed in a position where it is exposed to average daylight intensity, for example in the middle of the room or close to work stations for which the light control is calibrated.
- The light sensor should be placed above a suitable surface, if possible. Ideally, this surface should also be used as a reference surface for lighting intensity calibration. It should have a medium reflectance value. Well-suited surfaces are desktop surfaces or light grey path surfaces.
- It is important to observe that no objects which might impact sensor functions are placed underneath the sensor, e.g. palettes or taller pieces of furniture.

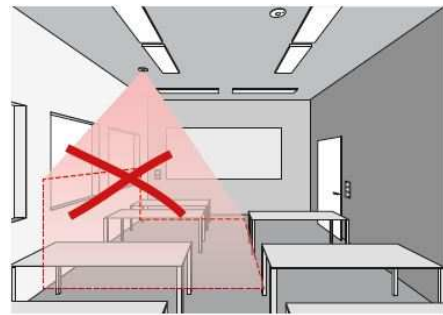

### **Sources of interference**

Avoid placement near any of the following sources of interference:

- Ventilation systems or sources of heat, e.g. heaters or video projectors
- Sources of light interference, e.g. luminaires with an indirect light component that directly hits the sensor
- Daylight reflection, e.g. from mirrors
- Radio or WLAN emitters at a distance of circa one metre

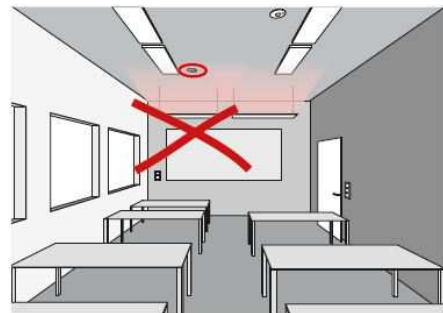

### **Further sensor information**

For further detailed sensor information and data please refer to the system manual or the sensor specification sheet.

### Functional description

#### Daylight-dependent control (semi-automatic operation)

The luminaires (close to/distant from windows) are controlled individually depending on daylight and switched off when daylight is sufficient. After switching off, lighting must be switched back on manually, even when values fall below the nominal value. Luminaire group 3 (board lighting) is not controlled depending on daylight and follows the switching states of group 1.

#### Presence detection (semi-automatic operation)

The detection range diameter for each sensor is 6 m for an installation height of 3 m. This Use Case is for the operating mode semi-automatic. In this case, the entire lighting (room and board luminaires) is switched off automatically after a variable switch-off delay once the room is left empty. In semi-automatic operation, there is no automatic switching on when movement is detected again. The operating mode semi-automatic requires manual switching on via push button T1.

#### App download

The system is set up with the app "LiveLink Install". System requirements are either an iOS or an Android tablet.

The apps can be found in the Apple App Store or the Google Play Store.



[www.trilux.com/livelink-app](http://www.trilux.com/livelink-app)



#### Commissioning

Commissioning LiveLink is done in next to no time – thanks to a simple graphic user interface featuring intuitive and comfortable operation. For this purpose, the control unit sets up its own secure WLAN. From that point on, the user communicates directly with the system through the commissioning app "LiveLink Install" on a tablet.

LiveLink Install guides the user through commissioning step by step. Intelligent control and feedback functions give the installer a maximum of security. When luminaires and sensors are tapped in the app, they flash. Mix-ups are impossible. Configuration is done via drag & drop. All steps are intuitively comprehensible, even for first-time users.

For help during commissioning, we provide you with our LiveLink system manual which is enclosed with every LiveLink system. You can also find the system manual on our homepage [www.trilux.com/livelink](http://www.trilux.com/livelink).

### Push button assignment

Push buttons are connected to a light scene or a luminaire group. When a light scene is assigned to a push button, said light scene is later activated at the press of the button. When a luminaire group is assigned to a push button, said luminaire group is later dimmed or switched on at the press of the button (Touch Dim function). One push button can only be occupied by one single light scene. In the Use Case Classroom the push buttons should be programmed as luminaire group push buttons as depicted in the plan.

### Luminaire group push button functions (Default scene)

Push button operation	Function	Note
T1		
Short button press	ON/OFF	When switching on, room lighting always starts up in the Default scene; with Standard Use Case settings in daylight-dependent standard operation.
Long button press	Dimming	Dimming automatically switches over to manual operation and the set artificial light level remains consistent. Presence detection remains active.
T2		
Short button press	ON/OFF	When switching on, board lighting always starts off in manual, uncontrolled operation. (Default scene)
Long button press	Dimming	When dimming, the set artificial light level remains consistent. Board lighting is switched off along with room lighting through presence detection.

#### Push button coupler note:

A maximum of 4 commercially available push buttons with one normally open contact can be connected to each push button coupler. If more than 4 push buttons are required, more push button couplers can be integrated. (1 push button coupler = 1 DALI device)

### List of components

Pcs.	Reference		Note
1	Luminaire	5041RPX-L 4000-840 ETDD +LLWM (example luminaire)	Master luminaire with DALI control gear unit, LiveLink controller and sensor.
1	Luminaire	5041RPX-L 4000-840 ETDD +LLWS (example luminaire)	Luminaire with DALI control gear unit and sensor.
4	Luminaire	5041RPX-L 4000-840 ETDD (example luminaire)	Luminaire with DALI control gear unit
2	Luminaire	5041RAV-L 4900-840 ETDD (example luminaire)	Luminaire with DALI control gear unit (wallwasher optic)



**TRILUX**  
SIMPLIFY YOUR LIGHT.

**General plan:**

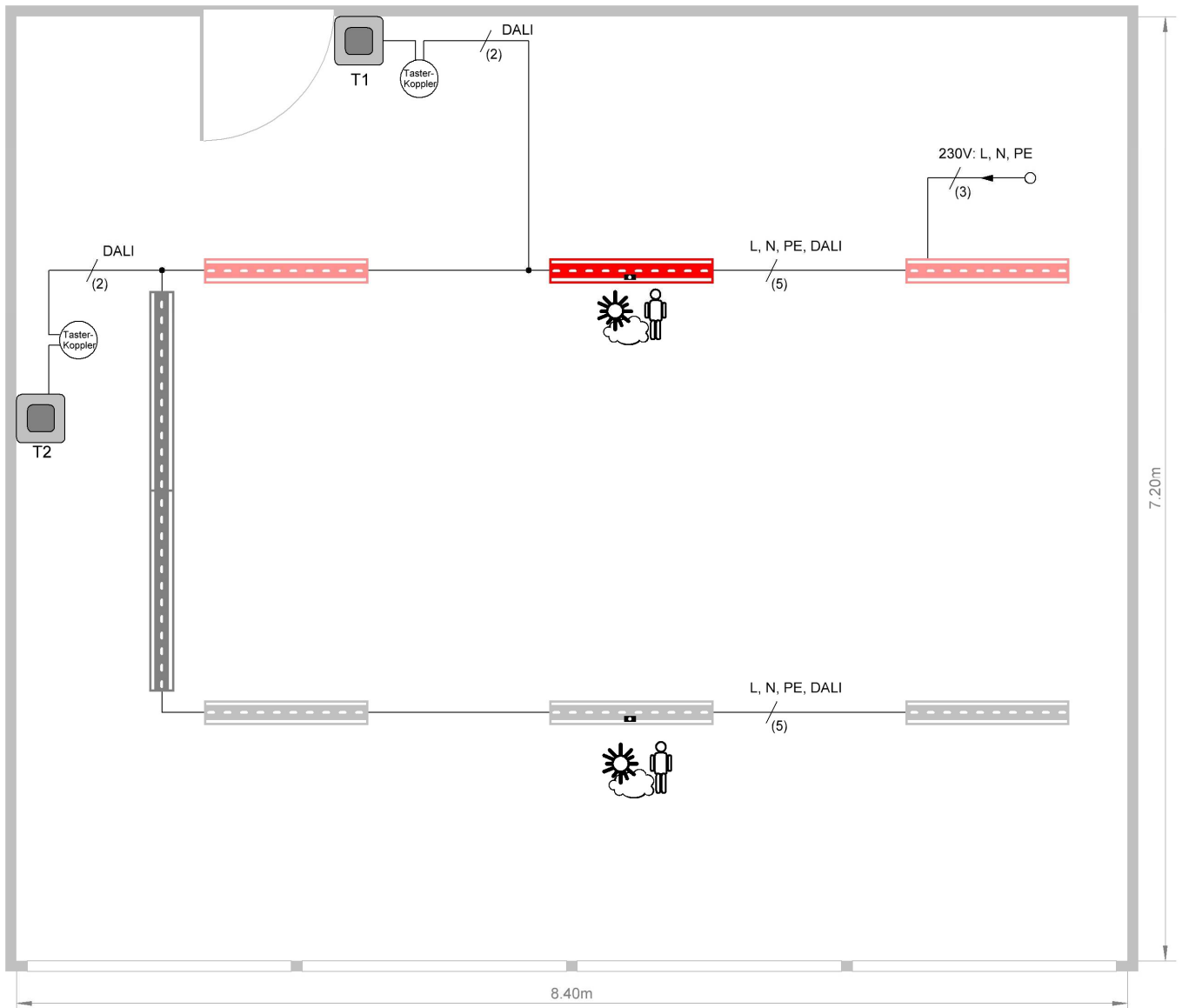

Luminaire with DALI control gear unit  
LiveLink controller & sensor, group 1



Luminaire with DALI control gear unit  
and LiveLink sensor, group 2



Luminaire with DALI control gear unit, group 1



Luminaire with DALI control gear unit, group 2



Luminaire with DALI control unit (Wallwasher)



Push button







Push button coupler

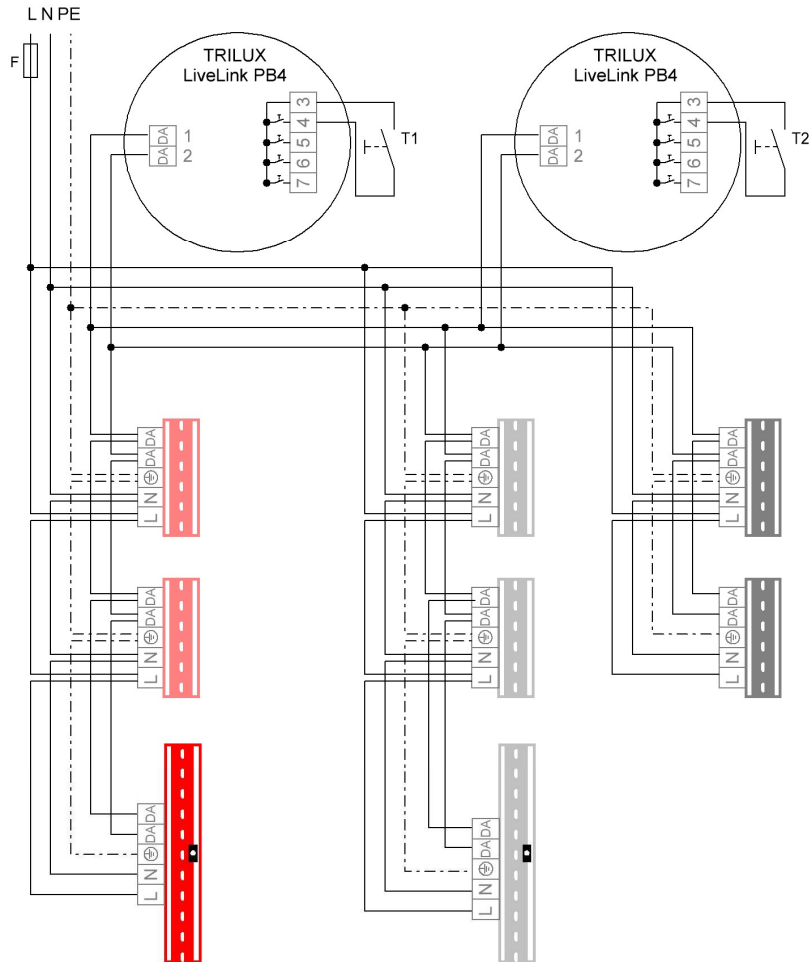

**Wiring plan:**



-  Luminaire with DALI control gear unit LiveLink controller & sensor, group 1
-  Luminaire with DALI control gear unit and LiveLink sensor, group 2
-  Luminaire with DALI control gear unit, group 1
-  Luminaire with DALI control gear unit, group 2
-  Luminaire with DALI control unit (Wallwasher)

