

DE MONTAGEANLEITUNG
EN MOUNTING INSTRUCTIONS
FR INSTRUCTIONS DE MONTAGE
IT ISTRUZIONI DI MONTAGGIO
ES INSTRUCCIONES DE MONTAJE
NL MONTAGEHANDLEIDING
PL INSTRUKCJA MONTAŻU



TRILUX
SIMPLIFY YOUR LIGHT

LIVELINK PREMIUM

SERVER KIT 1
SERVER KIT 2
SERVER KIT 3
SERVER KIT 4
SERVER KIT 5

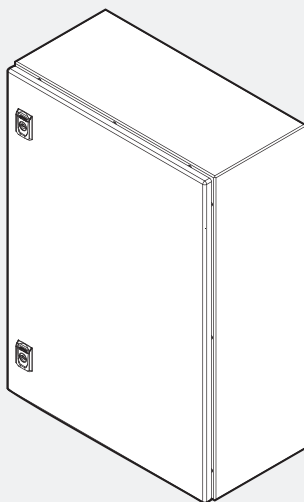
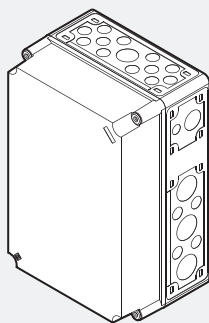



DE

LIVELINK PREMIUM SERVER KIT

Zu Ihrer Sicherheit

Lesen Sie sorgfältig alle Hinweise und Montageschritte. Bewahren Sie die Anleitung für Wartungs- oder Demontearbeiten auf.

Erläuterung der Warnstufen

Beachten und befolgen Sie die Warnhinweise. Nichtbeachten der Warnhinweise kann zu Verletzungen oder Sachschäden führen!



WARNUNG! Kennzeichnet Gefahren, die schwere und/oder tödliche Verletzungen zur Folge haben können.



VORSICHT! Kennzeichnet Gefahren, die zu Verletzungen oder Gesundheitsgefährdungen führen können.



WICHTIG. Kennzeichnet Gefahren, die zu Sachschäden oder Funktionsstörungen führen können.



TIPP. Kennzeichnet Informationen, die einen Ratschlag oder nützlichen Hinweis enthalten.

Erläuterung wichtiger Symboliken und Piktogramme



Kennzeichnet fachkundiges Personal, das ausgebildet und befugt ist, den elektrischen Anschluss auszuführen.



Kennzeichnet fachkundiges Personal, das ausgebildet und befugt ist, die Montage auszuführen.

Sicherheitshinweise



WARNUNG! Gefahr eines elektrischen Schlages! Arbeiten Sie niemals bei anliegender Spannung.



WARNUNG! Beachten Sie die Hinweise und Montageschritte der dazugehörigen Montageanleitung.



WARNUNG! Beachten Sie die Hinweise der Betriebsanleitung des Herstellers.



WARNUNG! Achten Sie bei der Auswahl der bauseitigen Befestigungsmittel auf die 5-fache Sicherheit.

Bestimmungsgemäße Verwendung

Bestimmt für Innenräume mit einer max. Umgebungstemperatur von: **ta 35 °C**

Schutzklasse: **I**

Schutzklasse: **II**

Schutzart: **IP54**

Entsorgung von Elektro- und Elektronik-Altgeräten



Sammeln und entsorgen Sie Elektro- und Elektronik-Altgeräte am Ende ihrer Lebensdauer immer getrennt.

Holen Sie sich im Zweifel Auskunft zur umweltgerechten Entsorgung bei der örtlichen Kommunalbehörde oder speziellen Entsorgungsfachbetrieben ein. Aktuelle Informationen zur Energieeffizienzklasse der gewählten Produktvariante finden Sie im entsprechenden Datenblatt der Leuchte. Hinweise zum Austausch oder zur Demontage des Leuchtmittels gemäß Verordnung 2019/2020/EU finden Sie unter:

www.trilux.com/EcoDesign

LIVELINK PREMIUM SERVER KIT

EN



For your safety

Read all instructions and mounting steps carefully. Keep the instructions for maintenance or disassembly work.

Explanation of the warning levels

Observe and follow the warnings. Non-observance of the warnings may lead to injuries or material damage!



WARNING! Indicates dangers which can result in serious and/or fatal injuries.



CAUTION! Indicates dangers which can result in injuries or health hazards.



NOTICE. Indicates dangers which can result in material damage or malfunctions.



TIP. Indicates information containing advice or a useful note.

Explanation of important symbols and pictograms



Indicates professional personnel who are trained and authorised to carry out the electrical connection.



Indicates professional personnel who are trained and authorised to carry out the mounting.

Safety notes



WARNING! Risk of electric shock! Never work with voltage applied.



WARNING! Observe the information and installation steps of the associated installation instructions.



WARNING! Observe the information in the manufacturer's operating instructions



WARNING! Observe the 5-fold safety when specifying the on-site mounting equipment.

Intended use

Intended for indoor use with a maximum ambient temperature of: **ta 35 °C**

Safety class: **I**

Safety class: **II**

Protection rating: **IP54**

Disposal of waste electrical and electronic equipment



Always collect and dispose of old electrical and electronic equipment separately at the end of its service life. In case of doubt, seek information about environmentally-compliant waste disposal from your local district authority or special waste disposal companies. Current information on the energy efficiency class of the selected product version can be found in the corresponding data sheet for the luminaire. Instructions for replacing or removing the light source in accordance with Regulation 2019/2020/EU can be found at:

www.trilux.com/EcoDesign



FR

LIVELINK PREMIUM SERVER KIT

Pour votre sécurité

Lisez attentivement toutes les remarques et étapes de montage. Conservez ces instructions pour des travaux d'entretien ou de démontage.

Explication des niveaux d'avertissement

Respectez et suivez les avertissements. Le non-respect des avertissements peut entraîner des blessures ou des dommages matériels !



AVERTISSEMENT ! Signale des risques pouvant résulter dans des blessures graves et/ou mortelles.



ATTENTION ! Signale des risques pouvant entraîner des blessures ou des risques pour la santé.



IMPORTANT. Signale des risques pouvant entraîner des dommages matériels ou des dysfonctionnements.



CONSEIL. Signale des informations contenant un conseil ou une remarque utile.

Explication des symboles et pictogrammes importants

Signale un personnel qualifié, formé et autorisé à effectuer le raccordement électrique.



Signale un personnel qualifié, formé et autorisé à effectuer le montage.

Recommandations de sécurité**AVERTISSEMENT !**

Risque d'électrocution ! Ne travaillez jamais sous tension.



AVERTISSEMENT ! Respectez les remarques et les étapes de montage des instructions de montage.



AVERTISSEMENT ! Veuillez respecter les indications et les étapes de montage figurant dans les mode d'emploi du fabricant



AVERTISSEMENT ! En sélectionnant les fixations en attente, pensez à la sécurité quintuple.

Utilisation conforme à l'usage prévu

Conçu pour des espaces intérieurs à la température ambiante maximale de : t_a 35 °C

Classe électrique : I

Classe électrique : II

Indice de protection : IP54

Élimination de DEEE

À la fin de leur durée de vie, collectez et éliminez toujours les DEEE de manière sélective. Si vous avez des doutes sur une élimination sans danger pour l'environnement, demandez auprès des autorités locales ou d'entreprises de valorisation. Vous trouverez des informations actuelles sur la classe d'efficacité énergétique de la version de produit choisie dans la feuille de données correspondante du luminaire. Vous trouverez des instructions sur l'échange ou le démontage de la lampe selon le règlement (UE) 2019/2020 à l'adresse :

www.trilux.com/EcoDesign

LIVELINK PREMIUM SERVER KIT

IT

**Per la propria sicurezza**

Leggere con attenzione tutti gli avvisi e le descrizioni delle varie fasi della procedura di montaggio. Conservare le istruzioni per poterle consultare al momento di eseguire lavori di manutenzione e smontaggio.

Spiegazione dei livelli di avvertenza

Osservare e attenersi alle avvertenze. Una mancata osservanza delle avvertenze può essere causa di lesioni o danni materiali!



AVVERTENZA! Mette in guardia dai pericoli che possono comportare lesioni gravi e/o mortali.



ATTENZIONE! Mette in guardia da pericoli che possono essere causa di lesioni o rischi per la salute.



AVVISO. Mette in guardia da pericoli che possono essere causa di danni materiali o disturbi di funzionamento.



SUGGERIMENTO. Indica informazioni comprendenti un consiglio o un avviso utile.

Spiegazione di importanti simboli e pittogrammi

Indica personale specializzato in possesso di formazione e autorizzazione necessarie per eseguire l'allacciamento elettrico.



Indica personale specializzato in possesso di formazione e autorizzazione necessarie per eseguire il montaggio.

Avvertenze di sicurezza

AVVERTENZA! Pericolo di scarica elettrica! Mai lavorare in presenza di tensione.



AVVERTENZA! Osservare gli avvisi e la sequenza di montaggio esposti nelle istruzioni specifiche.



AVVERTENZA! Osservare le indicazioni e le tappe della procedura di montaggio esposte nelle istruzioni per l'uso del produttore.



AVVERTENZA! Quando si scelgono gli elementi di fissaggio in cantiere, si deve fare attenzione che dispongano di sicurezza quintupla.

Impiego secondo destinazione

Destinato all'impiego in interni con una temperatura ambiente massima (ta) di 35 °C

Classe di isolamento: I

Classe di isolamento: II

Grado di protezione: IP54

Smaltimento di rifiuti di apparecchiature elettriche ed elettroniche

Alla fine del loro periodo di durata utile, raccogliere e smaltire i rifiuti di apparecchiature elettriche ed elettroniche sempre in modo differenziato. Nel dubbio, si raccomanda di chiedere informazioni su uno smaltimento conforme alla normativa ambientale presso le autorità municipali del posto o aziende specializzate nello smaltimento di rifiuti. Per informazioni aggiornate sulla classe di efficienza energetica della variante di prodotto scelta si rimanda alla scheda tecnica del rispettivo apparecchio. Indicazioni sulla sostituzione o lo smontaggio della lampada secondo regolamento 2019/2020/UE possono essere consultate su: www.trilux.com/EcoDesign

**ES****LIVELINK PREMIUM SERVER KIT****Para su seguridad**

Por favor, lea detenidamente todas las indicaciones y los pasos de montaje. Guarde las instrucciones para los trabajos de mantenimiento y desmontaje.

Explicación de los niveles de alerta

Por favor, tenga en cuenta y siga las indicaciones de peligro. ¡El incumplimiento de las indicaciones de peligro puede provocar lesiones o daños materiales!



¡ADVERTENCIA! Indica peligros que pueden provocar lesiones graves y/o mortales.



¡ATENCIÓN! Indica peligros que pueden provocar lesiones y riesgos de salud.



¡IMPORTANTE! Indica peligros que pueden provocar daños materiales o fallos de funcionamiento.



CONSEJO. Indica información con un consejo o una pista útil.

Explicación de los símbolos y pictogramas importantes

Indica personal profesional formado y autorizado para la realización de la conexión eléctrica.



Indica personal profesional formado y autorizado para la realización del montaje.

Avisos de seguridad

¡ADVERTENCIA! ¡Riesgo de descarga eléctrica! Nunca realice trabajos si esta tiene tensión.



¡ADVERTENCIA! Tenga en cuenta los avisos y los pasos de montaje de las instrucciones de montaje adjuntas.



¡ADVERTENCIA! Tenga en cuenta las indicaciones y los pasos indicaciones en las instrucciones de funcionamiento del fabricante.



¡ADVERTENCIA! Tenga en cuenta la seguridad quintuple al seleccionar los accesorios de fijación en la obra.

Uso previsto

Destinado para espacios interiores con una temperatura ambiente máxima: **ta de 35 °C**

Grado de protección: **I**

Grado de protección: **II**

Grado de protección: **IP54**

Eliminación de dispositivos eléctricos y electrónicos antiguos

Recoja y elimine los dispositivos eléctricos y electrónicos antiguos siempre por separado al final de su vida útil. En caso de duda, consulte las autoridades comunales o las empresas especializadas en eliminación de residuos para tener información sobre la eliminación respetuosa con el medio ambiente. En la ficha técnica de la luminaria correspondiente puede encontrar información actualizada sobre la clase de eficiencia energética de la variante de producto seleccionada. Para indicaciones sobre sustitución o desmontaje de la lámpara según el reglamento 2019/2020/EU consulte: www.trilux.com/EcoDesign

LIVELINK PREMIUM SERVER KIT**NL****Voor uw veiligheid**

Lees alle aanwijzingen en montagestappen zorgvuldig. Bewaar de handleiding voor latere onderhouds- of demontagewerkzaamheden.

Verklaring van de waarschuwniveaus

Neem de waarschuwingen in acht en volg de instructies. Bij niet-naleving kan letsel of materiële schade het gevolg zijn!



WAARSCHUWING! Wijst op gevaren die zware en/of dodelijke letsels tot gevolg kunnen hebben.



VOORZICHTIG! Wijst op gevaren die kunnen leiden tot letsels of gezondheidsrisico's.



BELANGRIJK! Wijst op gevaren die kunnen leiden tot materiële schade of functionele storingen.



TIP. Wijst op informatie die een advies of een nuttige aanwijzing bevat.

Verklaring van belangrijke symbolen en pictogrammen

Verwijst naar vakkundig personeel dat opgeleid en bevoegd is om de elektrische aansluiting uit te voeren.



Verwijst naar vakkundig personeel dat opgeleid en bevoegd is om de montage uit te voeren.

Veiligheidsinstructies

WAARSCHUWING! Gevaar voor een elektrische schok! Werk nooit terwijl deze onder spanning staat.



WAARSCHUWING! Neem de aanwijzingen en montagestappen in de bijbehorende montagehandleiding in acht.



WAARSCHUWING! De aanwijzingen en montagestappen in gebruiksaanwijzing van de fabrikant



WAARSCHUWING! Neem de 5-voudige veiligheid in acht bij de keuze van de bevestigingsmiddelen ter plaatse.

Bedoeld gebruik

Bedoeld voor binnengebruik bij een maximum omgevingstemperatuur van **ta 35 °C**

Beschermcategorie: **I**

Beschermcategorie: **II**

Beschermklasse: **IP54**

Afvoer van afgedankte elektrische en elektronische apparaten

Afgedankte elektrische en elektronische apparaten moeten altijd gescheiden van het andere afval worden bewaard en afgevoerd. Vraag in geval van twijfel aan de plaatselijke bevoegde openbare dienst of een gespecialiseerd afvalverwerkingsbedrijf hoe u deze apparaten afdankt met respect voor het milieu. Actuele informatie over de energie-efficiëntieklasse van de geselecteerde productvariant vindt u in het betreffende gegevensblad van de armatuur. Aanwijzingen met betrekking tot de vervanging of demontage van de lichtbron conform Verordening (EU) 2019/2020 vindt u op: www.trilux.com/EcoDesign



PL

LIVELINK PREMIUM SERVER KIT

Zasady bezpieczeństwa

Należy uważnie przeczytać wszystkie instrukcje i czynności montażowe. Zachować instrukcję na wypadek konserwacji lub demontażu.

Wyjaśnienie poziomów ostrzegania

Przestrzegać wskazówek ostrzegawczych. Nieprzestrzeganie wskazówek ostrzegawczych może spowodować obrażenia ciała lub szkody rzeczowe!



OSTRZEŻENIE! Oznacza zagrożenia, które mogą prowadzić do poważnych i/lub śmiertelnych obrażeń ciała.



UWAGA! Oznacza zagrożenia, które mogą prowadzić do obrażeń ciała lub zagrożenia dla zdrowia.



WSKAZÓWKA. Oznacza zagrożenia, które mogą prowadzić do szkód materialnych lub nieprawidłowego działania.



PORADA. Oznacza informacje, które zawierają poradę lub przydatną wskazówkę.

Wyjaśnienie ważnych symboli i piktogramów



Oznacza wykwalifikowany personel, który jest przeszkolony i upoważniony do wykonania przyłącza elektrycznego.



Określa kompetentny personel, który jest przeszkolony i upoważniony do przeprowadzenia montażu.

Wskazówki bezpieczeństwa



OSTRZEŻENIE! Niebezpieczeństwo porażenia prądem elektrycznym! Nigdy nie pracować pod napięciem.



OSTRZEŻENIE! Przestrzegać wskazówek i czynności montażowych zawartych w odpowiedniej instrukcji montażu.



OSTRZEŻENIE! Należy przestrzegać wskazówek w instrukcji obsługi producenta.



OSTRZEŻENIE! Przy wyborze elementów mocujących w miejscu montażu należy przestrzegać 5-krotnego bezpieczeństwa.

Zastosowanie zgodnie z przeznaczeniem

Przeznaczona do eksploatacji w pomieszczeniach o temperaturze otoczenia maksymalna: **ta 35°C**

Klasa ochronności: **I**

Klasa ochronności: **II**

Stopień ochrony: **IP54**

Utylizacja zużytego sprzętu elektrycznego i elektronicznego



Po zakończeniu okresu eksploatacji zużyte urządzenia elektryczne i elektroniczne należy zawsze zbierać i utylizować oddzielnie. W przypadku wątpliwości należy uzyskać informacje na temat przyjaznego dla środowiska usuwania odpadów od władz lokalnych lub firm zajmujących się utylizacją odpadów specjalnych. Aktualne informacje dotyczące klasy wydajności energetycznej wybranego wariantu produktu znaleźć można na odpowiedniej karcie katalogowej oprawy. Wskazówki dotyczące wymiany lub demontażu źródła światła zgodnie z rozporządzeniem UE 2019/2020 znaleźć można pod adresem: www.trilux.com/EcoDesign



LIVELINK PREMIUM SERVER KIT

Type
LIVELINK PREMIUM SERVER KIT 1

~ kg
8,8

A

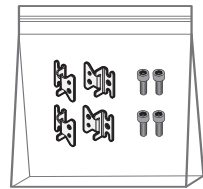
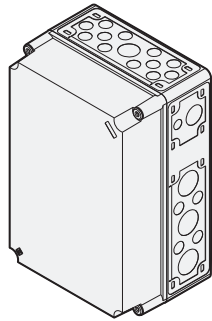

IP54

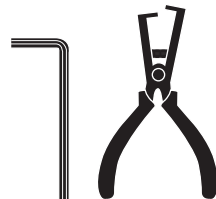

10

LIVELINK PREMIUM SERVER KIT



Type
LIVELINK PREMIUM SERVER KIT 1

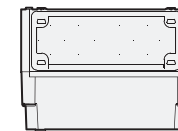
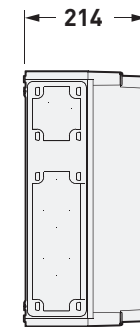
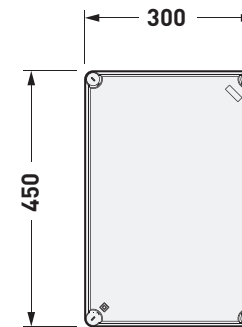



LIVELINK PREMIUM SERVER KIT

Type	≈ kg
LIVELINK PREMIUM SERVER KIT 2	21,9
LIVELINK PREMIUM SERVER KIT 3	22,0
LIVELINK PREMIUM SERVER KIT 4	22,1
LIVELINK PREMIUM SERVER KIT 5	22,2

B

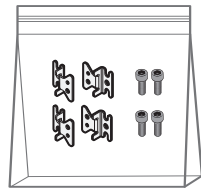
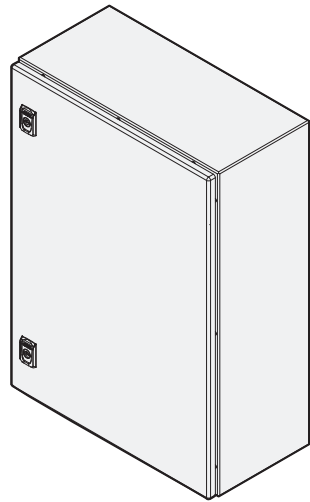

IP54

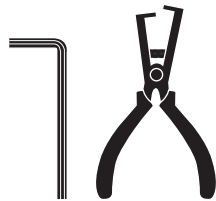

10

LIVELINK PREMIUM SERVER KIT



Type	≈ kg
LIVELINK PREMIUM SERVER KIT 2	21,9
LIVELINK PREMIUM SERVER KIT 3	22,0
LIVELINK PREMIUM SERVER KIT 4	22,1
LIVELINK PREMIUM SERVER KIT 5	22,2

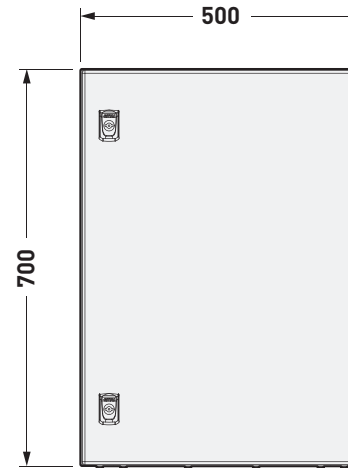



LIVELINK PREMIUM SERVER KIT

i

A



LLP Server Kit 1 = 1x Gateway

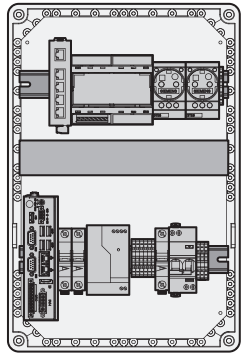

i

B



LLP Server Kit 2 = 3x Gateway
LLP Server Kit 3 = 4x Gateway
LLP Server Kit 4 = 5x Gateway
LLP Server Kit 5 = 6x Gateway

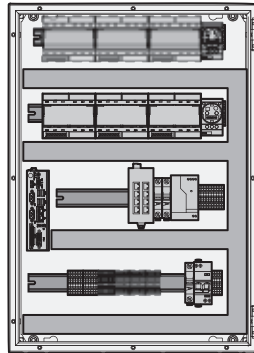

i

A

B

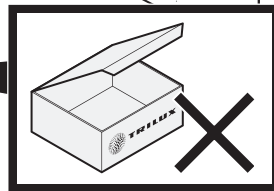
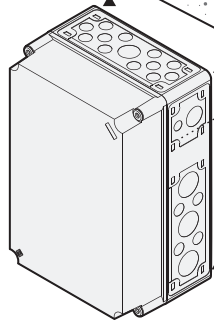
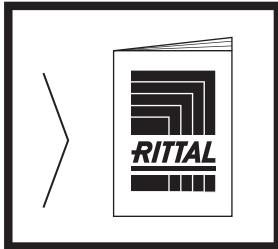

LIVELINK PREMIUM SERVER KIT



01

A

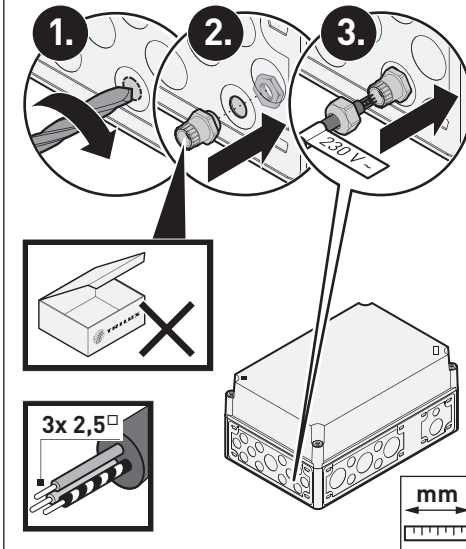

01

B

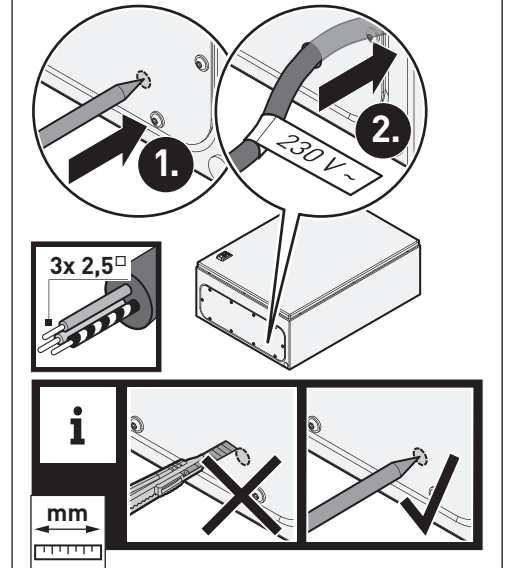

02

A

B

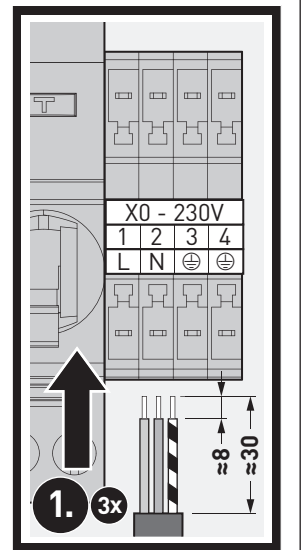
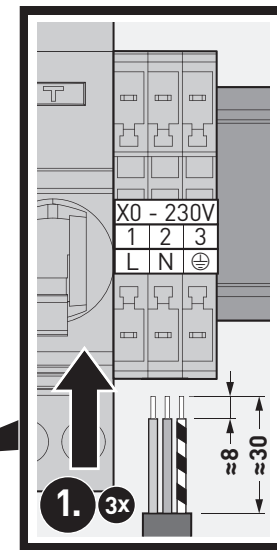
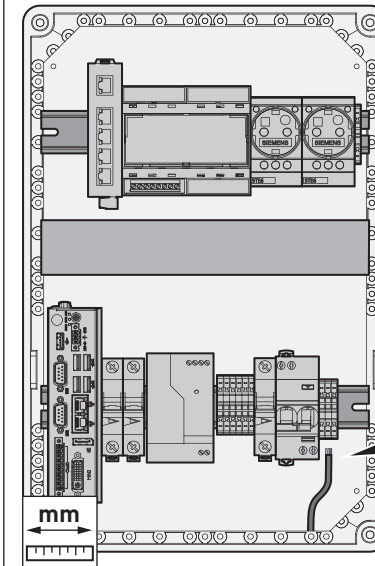



i

A

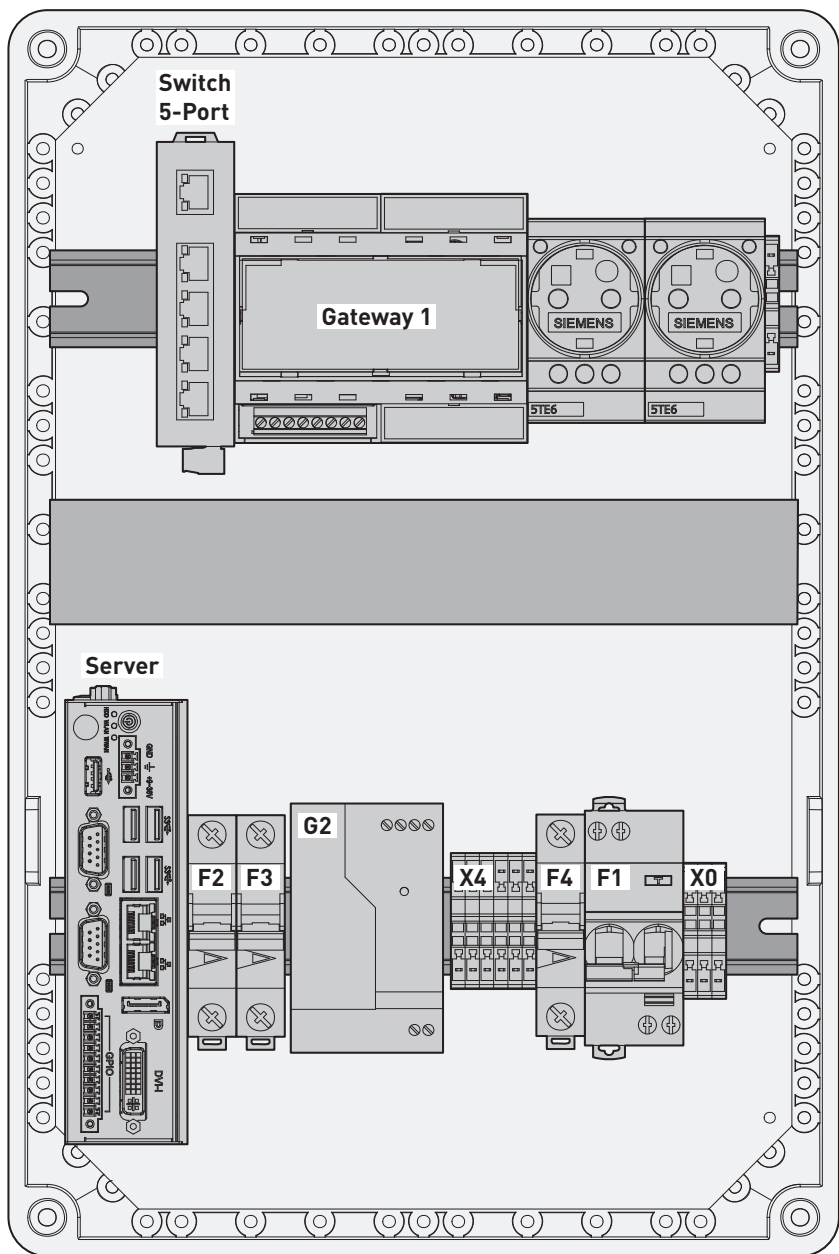

	Type LLP SWITCH 5-PORT	TOC 73 223 00
10237167		

	Type LLP GATEWAY	TOC 77 788 00
10206700		



	Type LLP SERVER	TOC 73 220 00
10237168		

	Type LLP POWER SUPPLY SERVER	TOC 73 221 00
10237170		

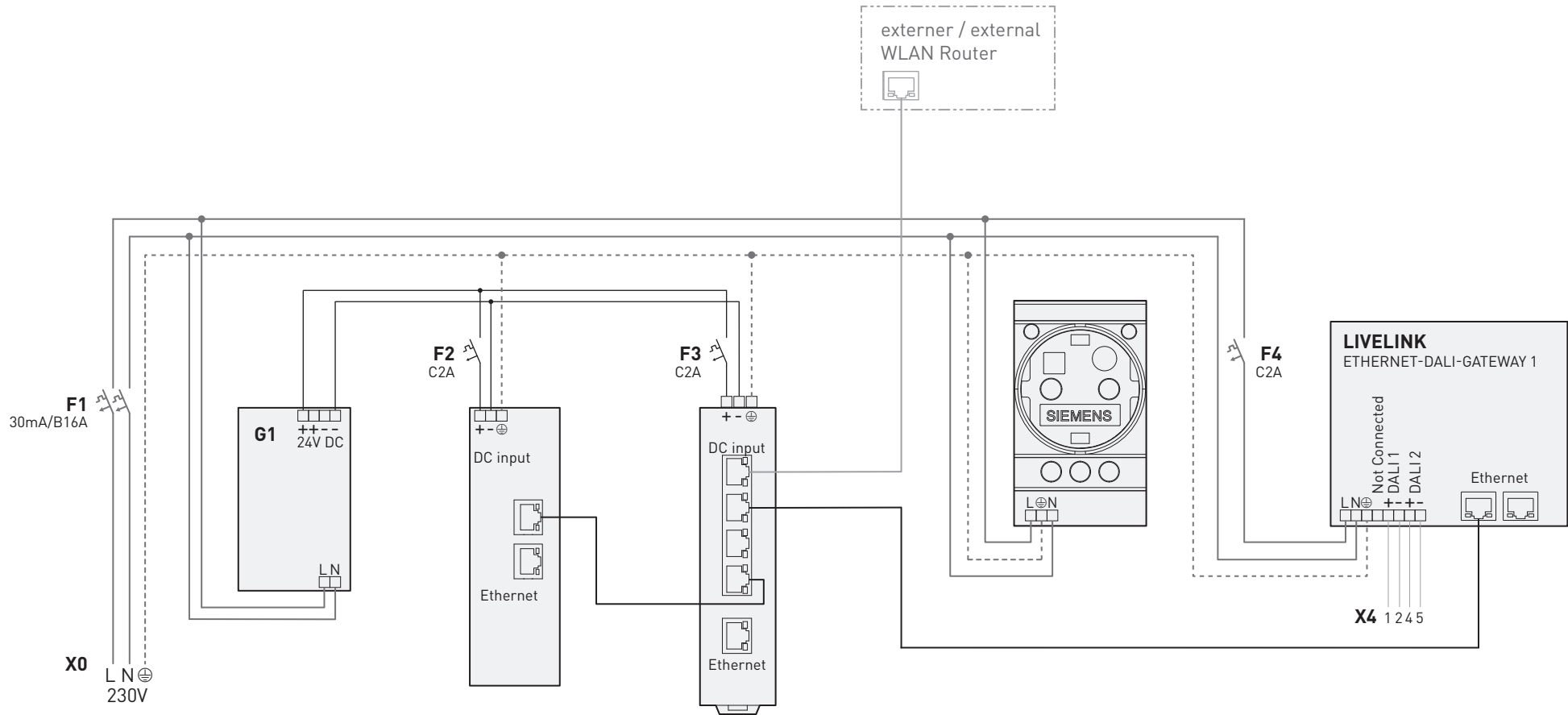

A



	Type LLP POWER SUPPLY SERVER	TOC 73 221 00		Type LLP SERVER	TOC 73 220 00		Type LLP SWITCH 5-PORT	TOC 73 223 00
---	--	------------------	---	-----------------------	------------------	--	---------------------------------	------------------

	Type LLP GATEWAY	TOC 77 788 00
---	------------------------	------------------



i

B

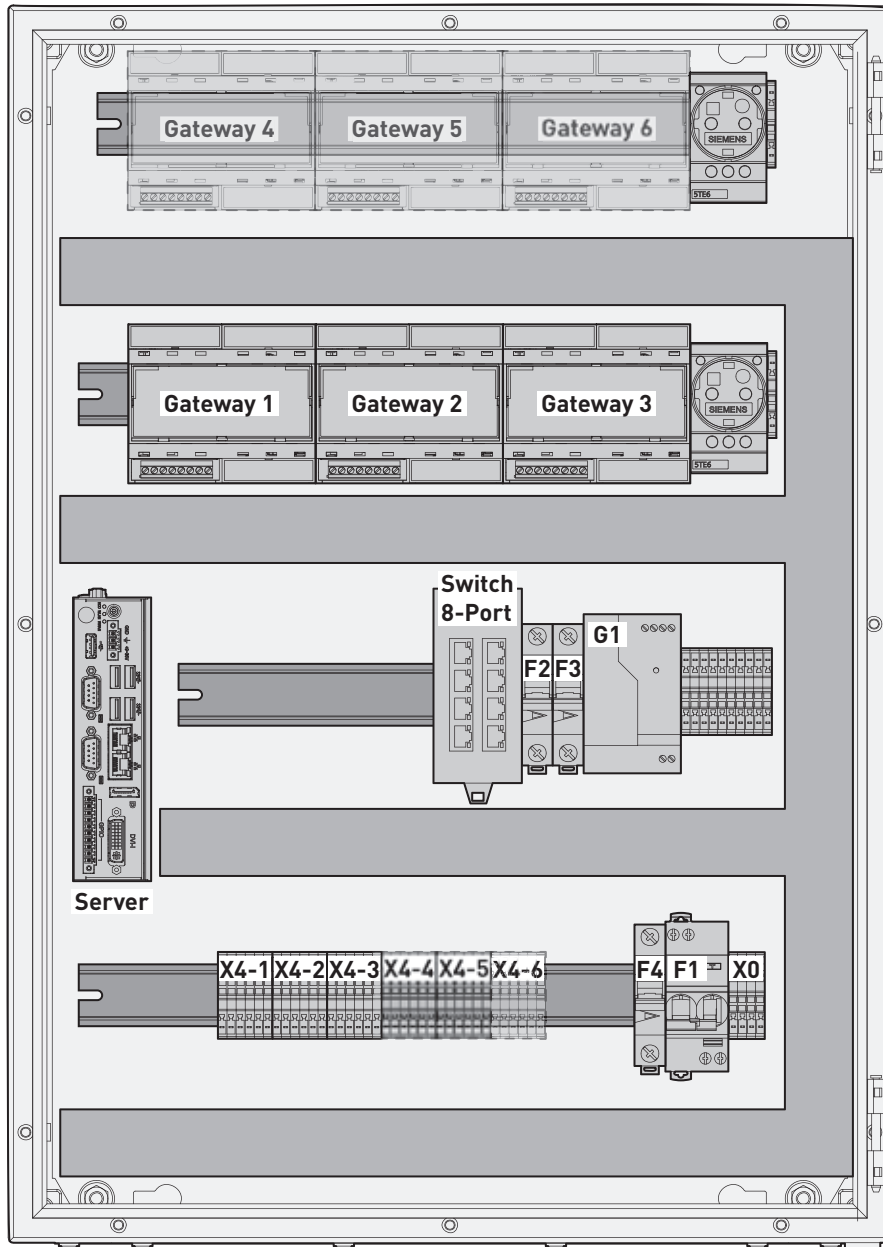

Type	TOC
LLP SWITCH 8-PORT	-

10237167

Type	TOC
LLP GATEWAY	77 788 00

10206700

Type	TOC
LLP SERVER	73 220 00

10237168

Type	TOC
LLP POWER SUPPLY SERVER	73 221 00

10237170



B

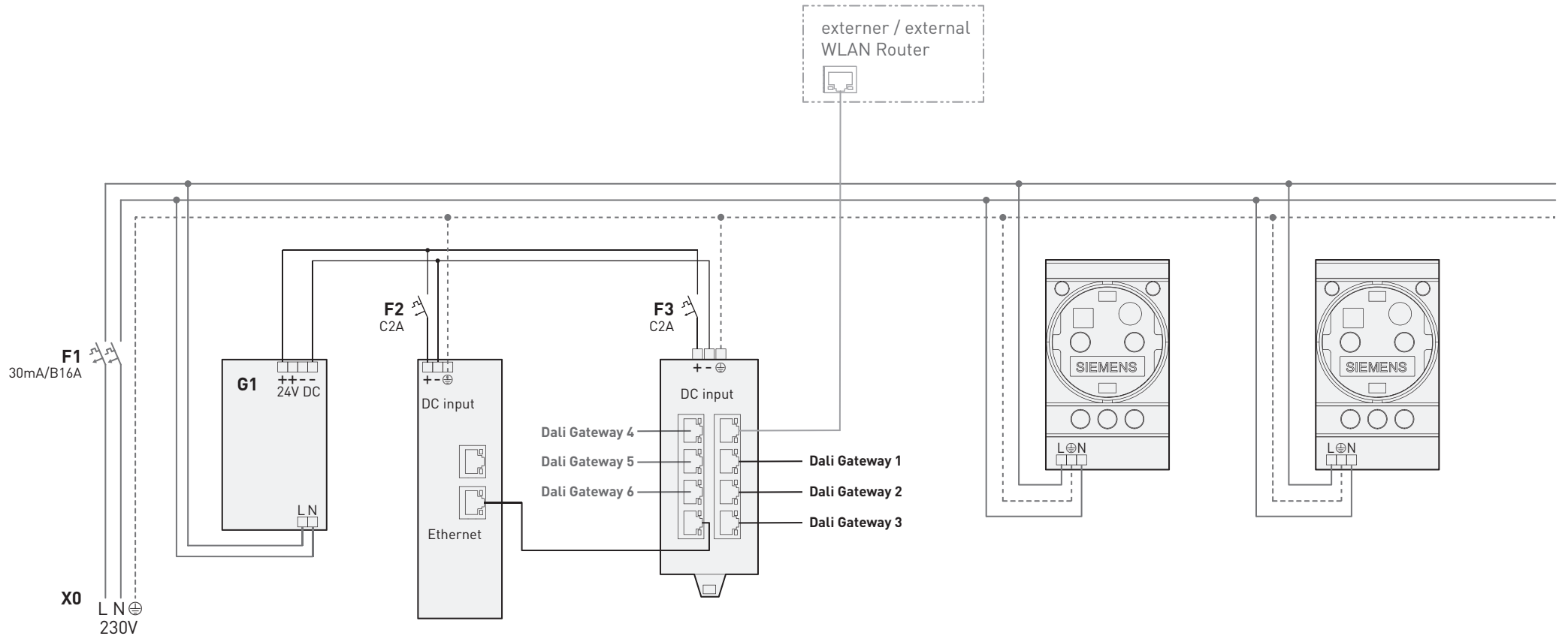

	Type	TOC			Type	TOC			Type	TOC	
	LLP POWER SUPPLY SERVER	73 221 00			LLP SERVER	73 220 00			LLP SWITCH 8-PORT	-	



B

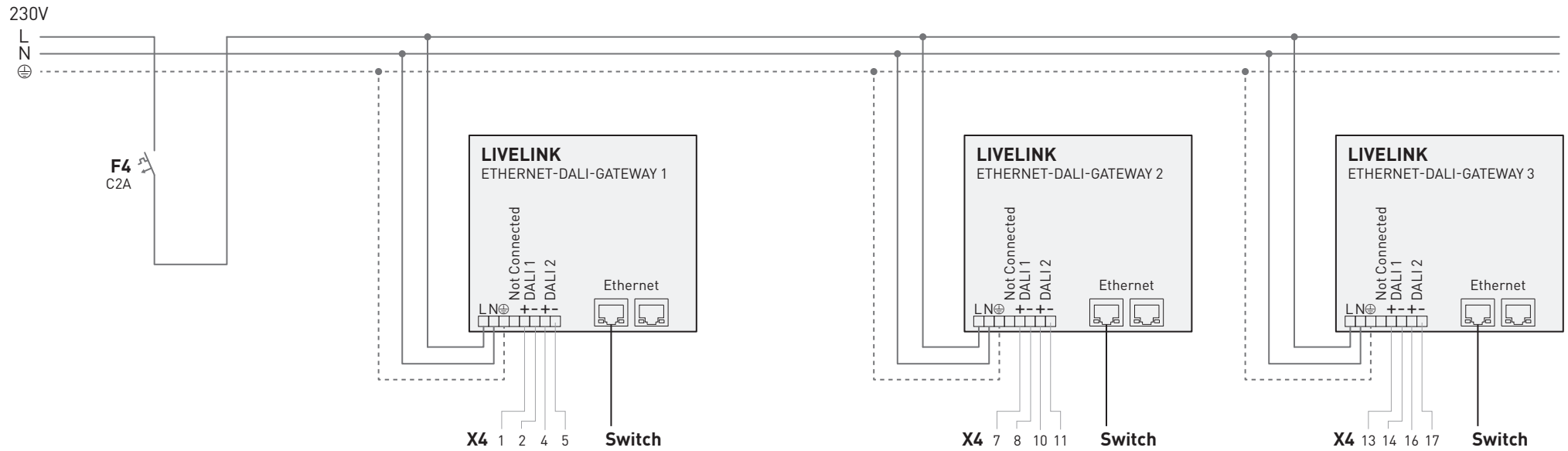



i

B

+ optional



LLP Server Kit 3
LLP Server Kit 4
LLP Server Kit 5

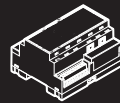
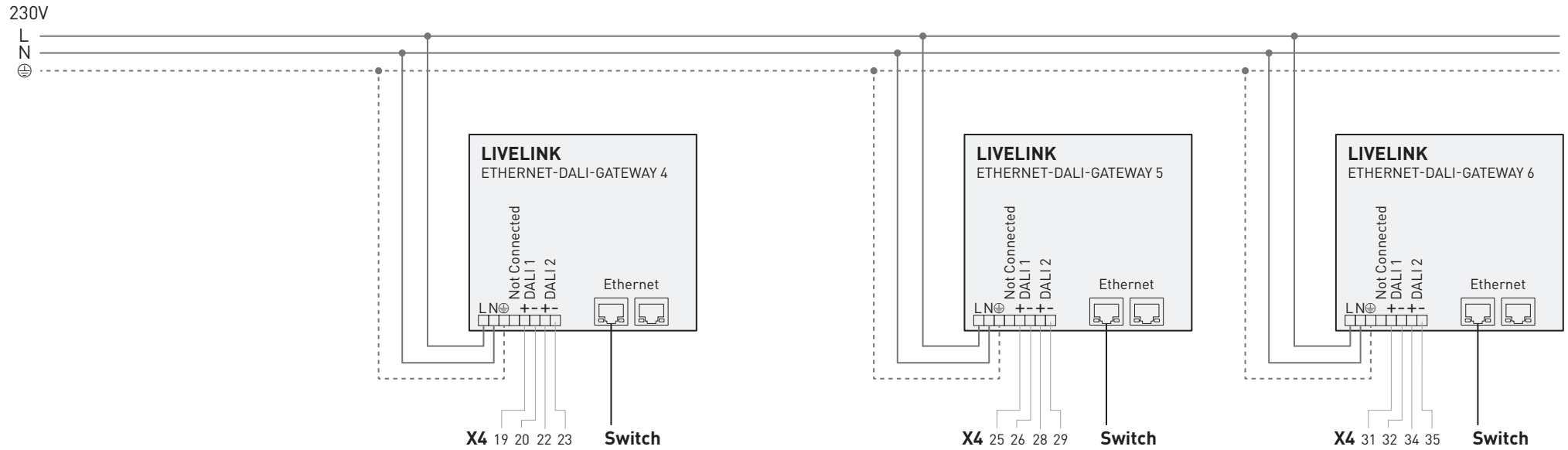

Type TOC
LLP 77 788 00
GATEWAY

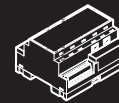

Type TOC
LLP 77 788 00
GATEWAY

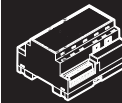

Type TOC
LLP 77 788 00
GATEWAY

TRILUX GmbH & Co. KG

Heidestraße
D-59759 Arnsberg
+49 2932 301-0
info@trilux.com
www.trilux.com