



Read this document carefully before using this device. The guarantee will be expired by damaging of the device if you don't attend to the directions in the user manual. Also we don't accept any compensations for personal injury, material damage or capital disadvantages.

# ENDA ETM442 DIGITAL TIMER

Thank you for choosing ENDA ETM442 digital timer.

- \* 48x48mm sized.
- \* 2x4 digits display.
- \* Easy to use by front panel keypad.
- \* Selectable 9 different time bases between 0-99.99s and 0-9999h.
- \* Selectable PNP or NPN sensor type.
- \* Selectable up/down counting direction for time.
- \* Adjustable Minimum On and Off times for pulses.
- \* Operation with or without memory for each output type.
- \* 9 different output types.
- \* Bottom display can be adjusted to show time unit or set value.
- \* Selectable functional reset.
- \* Parameter access protection on 3 levels.
- \* Easy connection by removable screw terminal.
- \* CE marked according to European Norms.

Order Code : ETM442-□□□□□□  
1



**Supply Voltage**  
230VAC...230V AC  
24VAC.....24V AC  
SM.....9-30V DC / 7-24V AC



## TECHNICAL SPECIFICATIONS

ENVIRONMENTAL CONDITIONS	
Ambient/storage temperature	0 ... +50°C/-25 ... +70°C (with no icing)
Max. relative humidity	80% up to 31°C decreasing linearly 50% at 40°C.
Rated pollution degree	According to EN 60529      Front panel : IP65 Rear panel : IP20
Height	Max. 2000m
Do not use the device in locations subject to corrosive and flammable gases.	

ELECTRICAL CHARACTERISTICS	
Supply	230V AC +10% -20%, 50/60Hz or 24V AC ±10%, 50/60Hz or optional 9-30V DC / 7-24V AC ±10% SMPS
Power consumption	Max. 5VA
Wiring	2.5mm <sup>2</sup> screw-terminal connections
Date retention	EEPROM (Min. 10 years)
EMC	EN 61326-1: 2006
Safety requirements	EN 61010-1: 2010 (pollution degree 2, overvoltage category II)

INPUTS	
START input	Input types can be adjusted as PNP or NPN in programming mode. Minimum On and Off times for input pulses can be adjusted between 5 and 100ms. For PNP input types, active level is 5 to 30V pulse, For NPN input types, active level is 0 to 2V pulse.
GATE input	
RESET input	

OUTPUTS	
Control output (OUT)	Relay : 250V AC, 2A (for resistive load), NO+NC Open collector output (S.S. OUT): Max. 30V DC, 100mA
Auxiliary power supply	12V DC, max. 50mA (without regulation)
Life expectancy for relay	Mechanical 30.000.000 operation; Electrical 300.000 operation
Accuracy	± 0.1% ± 20ms
Note : Relay and S.S.OUT outputs are in synchronization . When OUT relay is energized S.S. OUT transistor goes into saturation.	

HOUSING	
Housing type	Suitable for flush-panel mounting according to DIN 43 700.
Dimensions	W48xH48xD87mm
Weight	Approx. 210g (after packing)
Enclosure material	Self extinguishing plastics
While cleaning the device, solvents (thinner, benzene, acid etc.) or corrosive materials must not be used.	

# TERMS

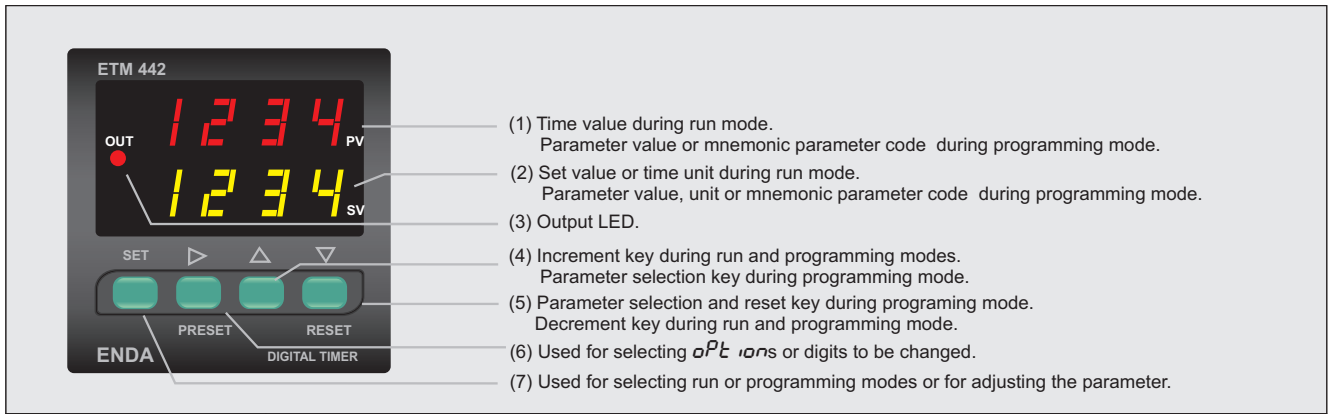

( 1 ) PV display	4 digits, 7 segment red LED
( 2 ) SV display	4 digits, 7 segment yellow LED
Character height	PV display (1) : 7.1mm
	SV display (2) : 7.1mm
( 3 ) Output LED	One red LED
( 4 ),( 5 ),( 6 ),( 7 ) Keypad	Micro switch

# DIMENSIONS

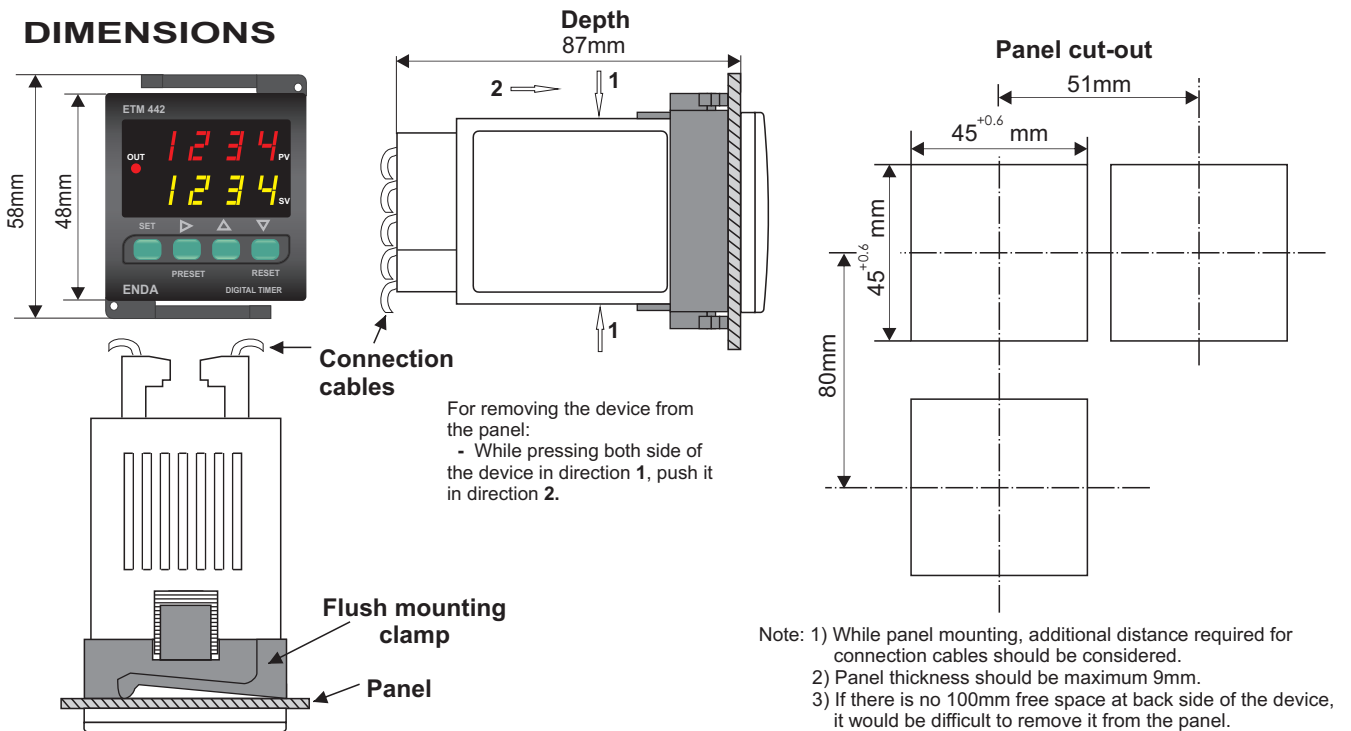

# CONNECTION DIAGRAM



ENDA ETM442 is intended for installation in control panels. Make sure that the device is used only for intended purpose. The shielding must be grounded on the instrument side. During an installation, all of the cables that are connected to the device must be free of energy. The device must be protected against inadmissible humidity, vibrations, severe soiling. Make sure that the operation temperature is not exceeded. All input and output lines that are not connected to the supply network must be laid out as shielded and twisted cables. These cables should not be close to the power cables or components. The installation and electrical connections must be carried on by a qualified staff and must be according to the relevant locally applicable regulations.

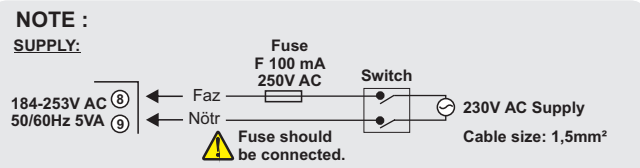
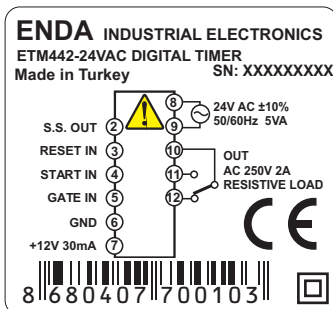
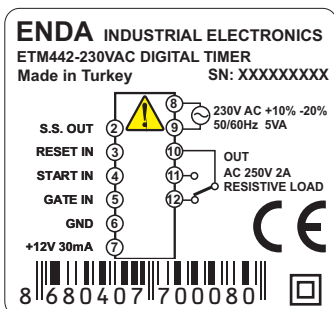

Note : 1) Mains supply cords shall meet the requirements of IEC 60227 or IEC 60245.  
 2) In accordance with the safety regulations, the power supply switch shall bring the identification of the relevant instrument and it should be easily accessible by the operator.

Holding screw 0.4-0.5Nm

Equipment is protected throughout by DOUBLE INSULATION.

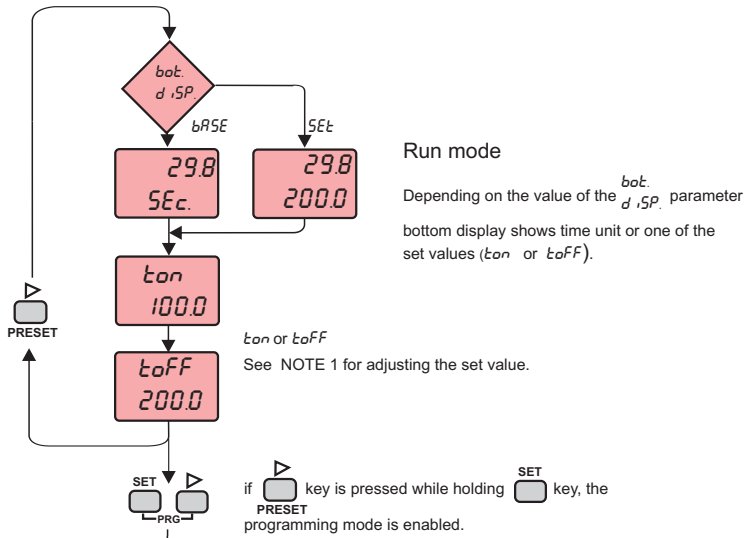

PARAMETER TABLE																			
InPt. oPlt.	<i>t nE bASE</i>	99.99 Sec.	999.9 SEc.	9999 SEc.	99.99 n in.	999.9 n in.	9999 n in.	99.99 Hour	999.9 Hour	9999 Hour	<i>bot. d.SP</i>	<i>bASE</i>		<i>SEt</i>					
	<i>SEnS. tYPE</i>	<i>nPn</i>	<i>PnP</i>									<i>SECU. codE</i>	1111						
	<i>t nE d ir.</i>	<i>UP</i>	<i>dn.</i>										<i>inP.o SECU.</i>	<i>nonE</i>	<i>Pr.oG. no</i>	<i>Pr.oG. YES</i>			
OutP. oPlt.	<i>outP. tYPE</i>	<i>ConF. 1</i>	<i>ConF. 2</i>	<i>ConF. 3</i>	<i>ConF. 4</i>	<i>ConF. 5</i>	<i>ConF. 6</i>	<i>ConF. 7</i>	<i>ConF. 8</i>	<i>ConF. 9</i>	<i>OutP. oPlt.</i>	<i>Out.o SECU.</i>	<i>nonE</i>	<i>Pr.oG. no</i>	<i>Pr.oG. YES</i>				
	<i>nE n. SEt</i>	<i>no</i>	<i>YES</i>									<i>d.S.o SECU.</i>	<i>nonE</i>	<i>Pr.oG. no</i>	<i>Pr.oG. YES</i>				
													<i>t nE r. SEt</i>	<i>no</i>	<i>Pr.oG. no</i>	<i>r. SEt inP.t.</i>	<i>both</i>		
												<i>dEF. SEt</i>	<i>no</i>	<i>YES</i>					

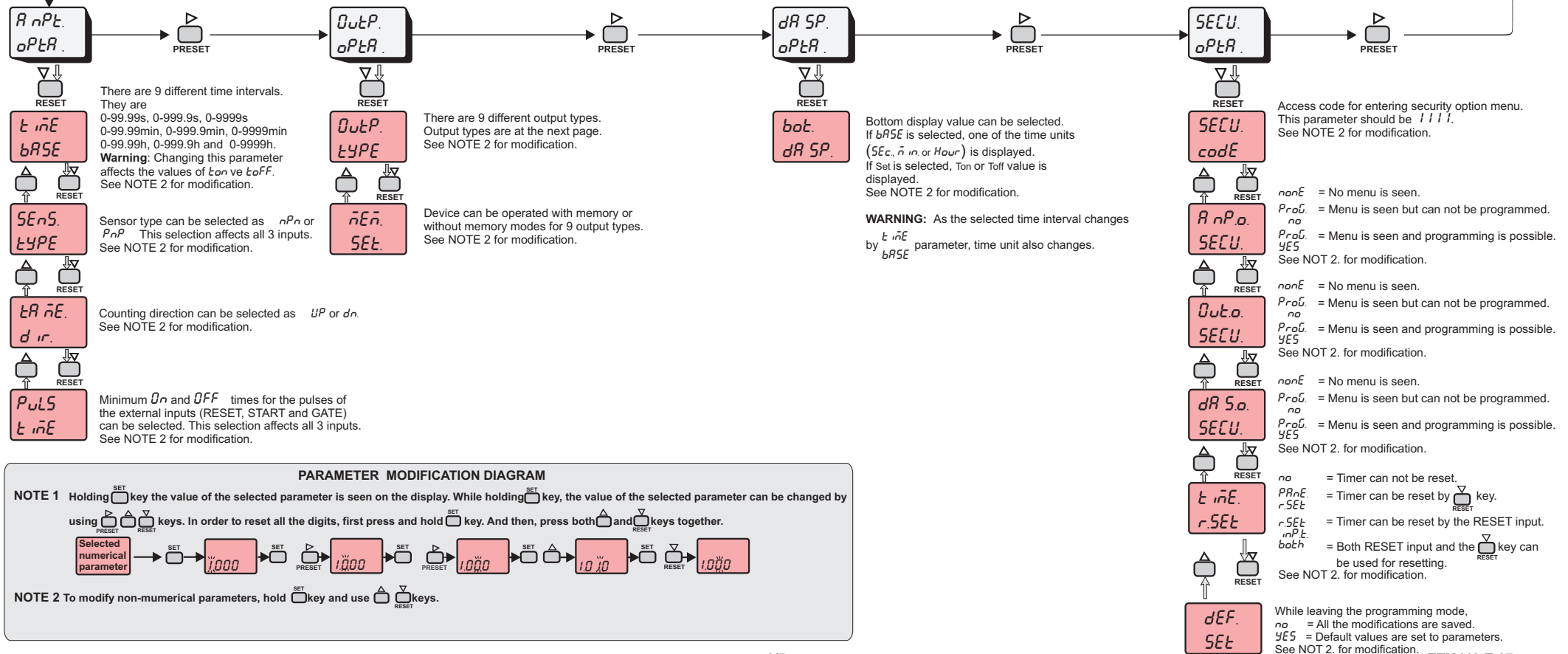

# OUTPUT TYPES

**TON: Relay On time**

**TOFF: Relay Off time**

Without memory

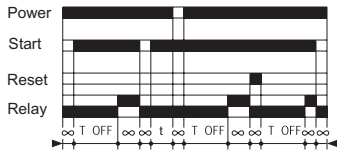

Config. 1  
Delay on energization

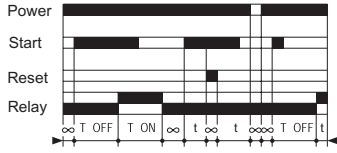

Config. 2  
Cyclic timing  
Single cycle

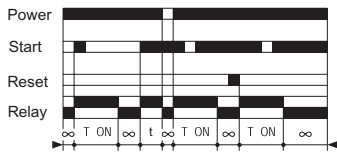

Config. 3  
Timing on impulse  
(one shot)

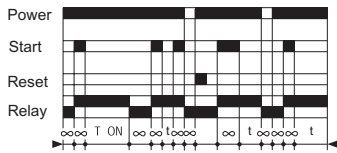

Config. 4  
Timing after impulse  
(delay off)

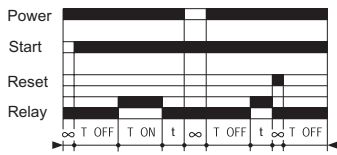

Config. 5  
Cyclic timing

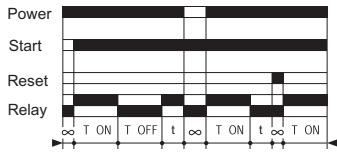

Config. 6  
Cyclic timing

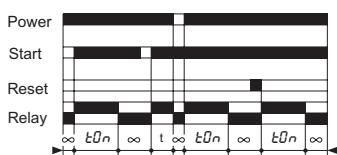

Config. 7  
Timing on energization

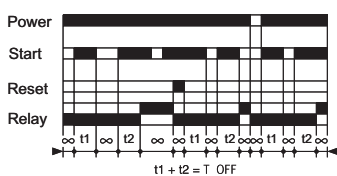

Config. 8  
Timing on energization  
with memory

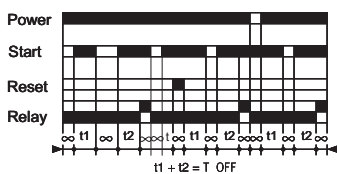

Config. 9  
Timing on energization  
with memory  
+reset by START input  
after TOFF

**t: Partial time of TON or TOFF.**

**∞ : Indefinite time**

With memory

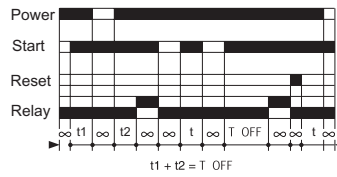

While the device is energized,  
If START is active, relay is energized after delay time (TOFF).

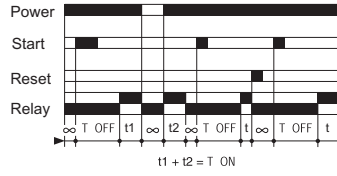

While the device is energized,  
If START input is active, relay becomes Off and On periodically during TOFF and TON times respectively. At the end of each TON time START input is checked. If it START is passive, timer stops and initial conditions are returned. Otherwise, periodic operation continues.

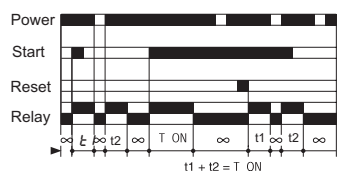

While the device is energized,  
With an impulse at the START input, relay becomes On during TON time. Then, relay becomes Off.

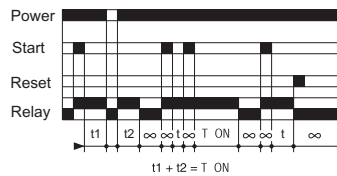

With an impulse at the START input, relay becomes On. However, timer do not counts while START is active. When START becomes passive, relay becomes Off after a time delay (TON).

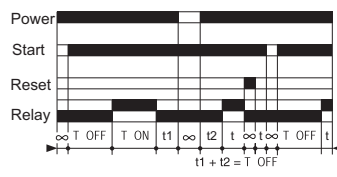

While the device is energized,  
If START input is active, relay becomes first Off and then On periodically during TOFF and TON times respectively. As soon as START becomes passive, timer stops and initial conditions are returned.

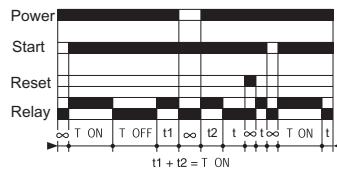

While the device is energized,  
If START input is active, first TON and then TOFF times are passed periodically. As soon as START becomes passive, timer stops and initial conditions are returned.

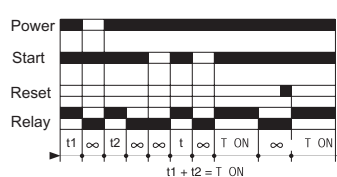

While the device is energized,  
If START input is active, relay becomes On during TON time. Then, relay becomes Off.

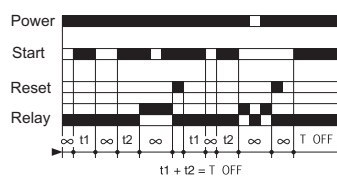

While the device is energized,  
If START is active, relay is energized after delay time (TOFF). If START becomes passive before TOFF time, timer waits for another active signal at the START input to complete the TOFF time.

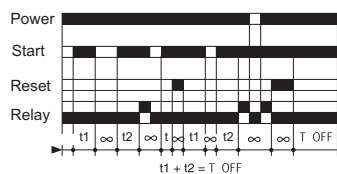

While the device is energized,  
If START is active, relay is energized after delay time (TOFF). If START becomes passive after TOFF time, reset occurs. Relay is de-energized and initial condition is returned.

NOTE: if Gate input becomes active, timer enters into wait mode. Timer waits at that condition until gate input becomes passive

## TERMINAL CONNECTIONS

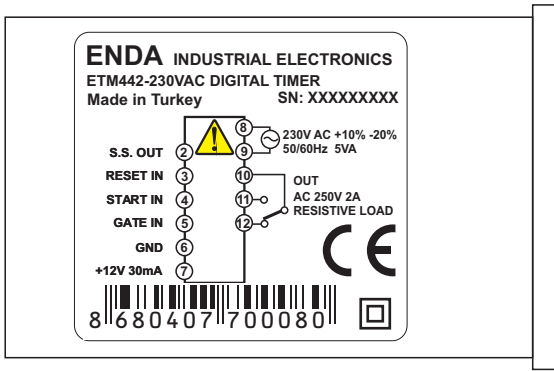

### Terminal description

- 2 : Solid state out (Max 30V 100mA, open collector NPN)
- 3 : Reset input (Max 30V)
- 4 : Start input (Max 30V)
- 5 : Gate input(Max 30V)
- 6 : GND
- 7 : +12V 30mA auxiliary supply output for sensors
- 8,9 : SUPPLY input
- 10,11,12 : Relay contacts (Max 2A 250V AC)

## TYPICAL SENSOR CONNECTIONS

### Typical connections for PNP sensor type

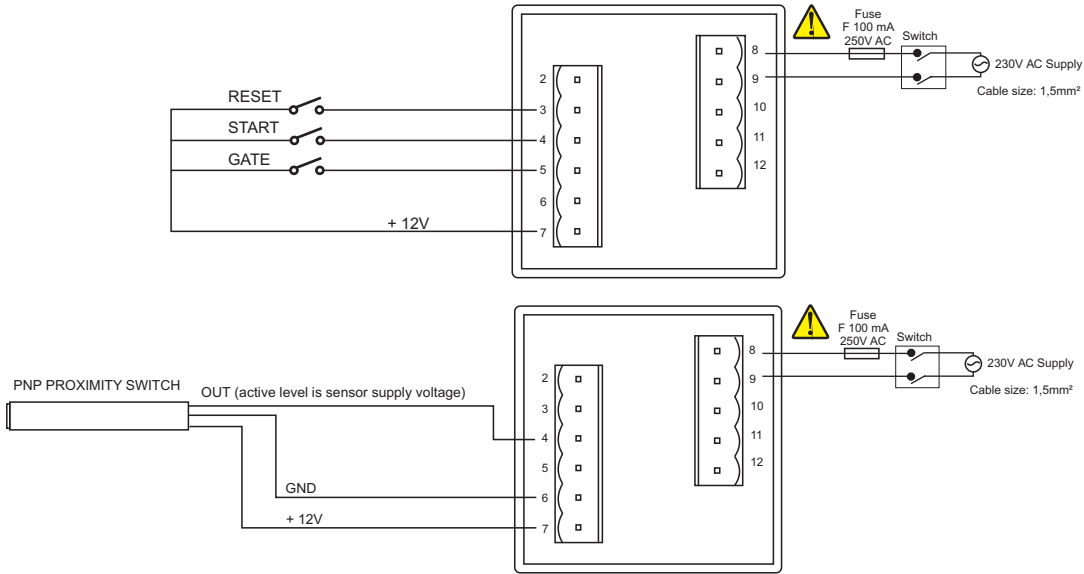

NOTE: FOR PNP SENSOR TYPE ACTIVE LEVEL IS AUXILIARY POWER SUPPLY VOLTAGE.

### Typical connections for NPN sensor type

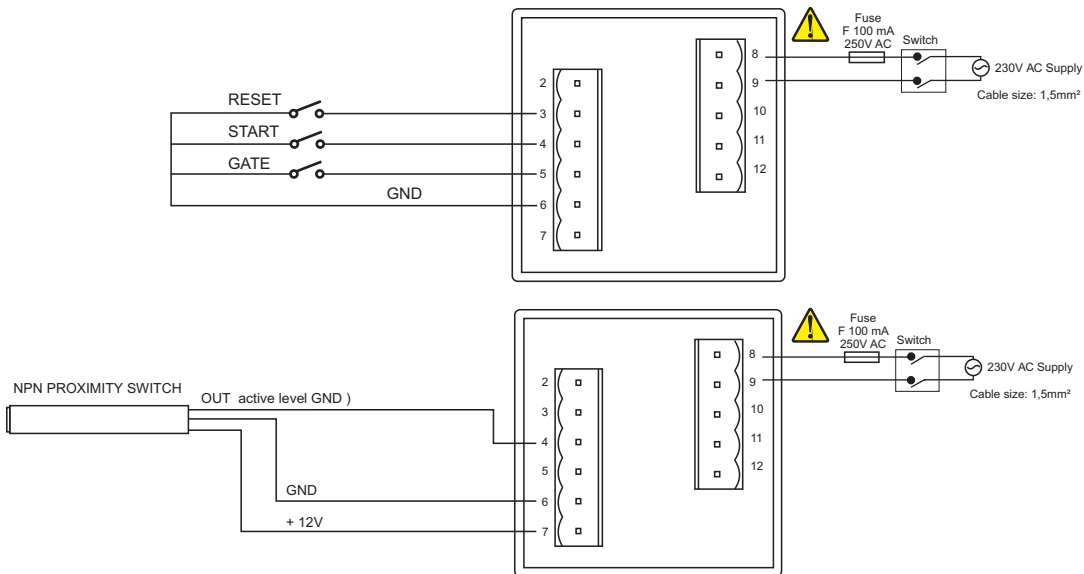

NOTE: FOR NPN SENSOR TYPE ACTIVE LEVEL IS GROUND (GND).