



Read this document carefully before using this device. The guarantee will be expired by device damages if you don't attend to the directions in the user manual. Also we don't accept any compensations for personal injury, material damage or capital disadvantages.

ENDA EPV942 PROGRAMMABLE AC/DC VOLTMETER

Thank you for choosing ENDA EPV942 Programmable AC/DC voltmeter.

- ▶ 96 x 96 mm sized
- ▶ 4 digits display
- ▶ Selectable number of decimal point
- ▶ Can be displayed between -999 and + 9999V by using voltage transformer
- ▶ Easy to use front panel keypad
- ▶ Multi-function alarm output for lower and upper limits (NO + NC)
- ▶ Multi-function alarm setpoints with alarm output (NO)
- ▶ Communication feature over isolated RS485, using ModBus RTU protocol (Optional)
- ▶ Measuring type can be selected as AC, DC or true RMS (ACDC)
- ▶ CE Marked according to European Norms.



Order Code : EPV942 - <u> </u> - <u> </u> - <u> </u>		
1	2	3
1 - Supply Voltage UV.....90-250V AC LV.....10-30V DC / 8-24V AC	2 -Output R.....10A(Out)Relay 2R.....10A(Out+Alr)Relay	3 - Modbus RSI.....RS485 Modbus Available (Specify at order)

R^{HS}
Compliant



ENVIRONMENTAL CONDITIONS	
Ambient / Storage Temperature	0 ... +50°C/-25 ... +70°C (with no icing)
Max. Relative Humidity	80% Relative humidity for temperatures up to 31°C, decreasing linearly to 50% at 40°C.
Rated Pollution Degree	According to EN 60529 ; Front Panel : IP65, Rear Panel : IP20
Height	Max. 2000m
KEEP AWAY device from exposed to corrosive, volatile and flammable gases or liquids and DO NOT USE the device in similar hazardous locations.	

ELECTRICAL CHARACTERISTICS							
Supply Voltage	90-250V AC 50/60Hz ; 10-30V DC / 8-24V AC SMPS						
Power Consumption	Max. 5VA						
Wiring	2.5mm ² screw-terminal connections						
Scale	<table border="0"> <tr> <td>AC and RMS</td> <td>For <i>u_{ERR}</i> 0...9999V, for <i>u₁₀₀</i> 0.....100V, for <i>u₅₀₀</i> 0...500V</td> </tr> <tr> <td>DC</td> <td>For <i>u_{ERR}</i> -999...9999V DC, for <i>u₁₀₀</i> -100...100V DC, for <i>u₅₀₀</i> -500...+500V DC</td> </tr> </table>	AC and RMS	For <i>u_{ERR}</i> 0...9999V, for <i>u₁₀₀</i> 0.....100V, for <i>u₅₀₀</i> 0...500V	DC	For <i>u_{ERR}</i> -999...9999V DC, for <i>u₁₀₀</i> -100...100V DC, for <i>u₅₀₀</i> -500...+500V DC		
AC and RMS	For <i>u_{ERR}</i> 0...9999V, for <i>u₁₀₀</i> 0.....100V, for <i>u₅₀₀</i> 0...500V						
DC	For <i>u_{ERR}</i> -999...9999V DC, for <i>u₁₀₀</i> -100...100V DC, for <i>u₅₀₀</i> -500...+500V DC						
Sensitivity	0,01V (If, <i>u_{ERR}</i> is selected) 0,1V (If, <i>u_{ERR}</i> or <i>u₅₀₀</i> is selected and higher than -100V, lower from 100V for input values) 1V (If <i>u_{ERR}</i> or <i>u₅₀₀</i> is selected and lower than -100V, higher from 100V for input values)						
Accuracy	<table border="0"> <tr> <td>AC</td> <td>±%1 (Full scale) (For square wave form ± 2%)</td> </tr> <tr> <td>DC</td> <td>±%1 (Full scale)</td> </tr> <tr> <td>RMS</td> <td>±%1 (Full scale) (For square wave form ± 2%)</td> </tr> </table>	AC	±%1 (Full scale) (For square wave form ± 2%)	DC	±%1 (Full scale)	RMS	±%1 (Full scale) (For square wave form ± 2%)
AC	±%1 (Full scale) (For square wave form ± 2%)						
DC	±%1 (Full scale)						
RMS	±%1 (Full scale) (For square wave form ± 2%)						
Input Range	-500V...500V (Device will be damaged if more than ±1250 DC voltages applied when <i>u₅₀₀</i> is selected) -100V...100V (Device will be damaged if more than ±250 DC voltages applied when <i>u₅₀₀</i> or <i>u_{ERR}</i> is selected)						
Input Impedance	870kΩ						
Frequency Range	DC , 10Hz - 200Hz (For square wave form 10Hz-70Hz)						
EMC	EN 61326-1: 2013						
Safety Requirements	EN 61010-1: 2010 (Pollution degree 2, overvoltage category II)						

OUTPUTS	
Output	250V AC, 10A (for resistive load), NO+NC
Alarm output	250V AC, 10A (for resistive load), NO+NC
Life expectancy for relay	Mechanical 30.000.000 ; Electrical 100.000 operation.

HOUSING	
Housing Type	Suitable for flush-panel mounting. (According to DIN 43 700)
Dimensions	W96xH96xD50mm
Weight	Approx. 410g (after packing)
Enclosure Material	Self extinguishing plastics.

Avoid any liquid contact when the device is switched on.
DO NOT clean the device with solvent (thinner, gasoline, acid etc.) and / or abrasive cleaning agents.



SISEL MÜHENDİSLİK ELEKTRONİK SAN. VE TİC. A.Ş.
Şerifali Mah. Barbaros Cad. No:18 Y.Duduluğu 34775
ÜMRANIYE/İSTANBUL-TURKEY
Tel : +90 216 499 46 64 Pbx. Fax : +90 216 365 74 01
url : www.enda.com.tr



EPV942-EN-03-220103

DIMENSIONS

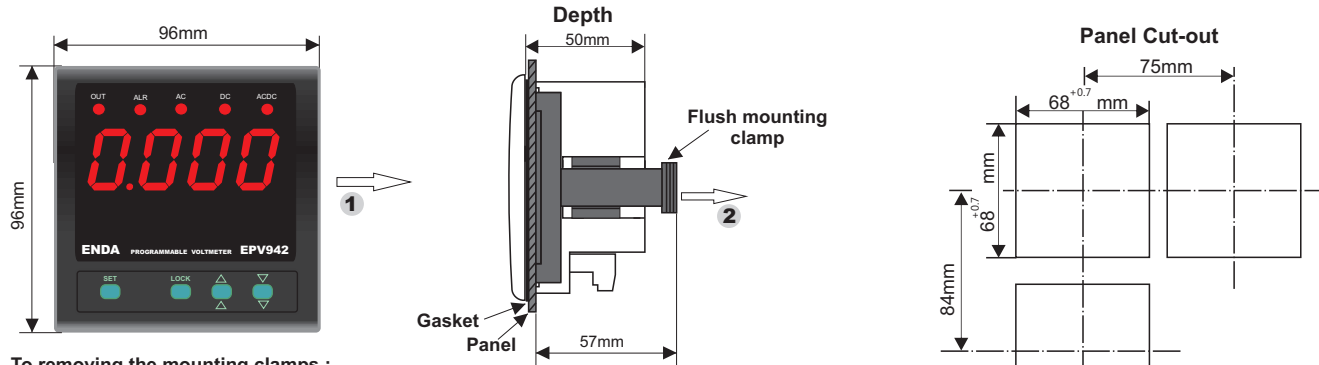

To removing the mounting clamps :

- Push the flush-mounting clamp in direction **1** as shown in the figure left.
- Then, pull out the clamp in direction **2**.



Note :

- 1) Panel thickness should be maximum 10mm.
- 2) There must be at least 60mm free space behind the device, otherwise it would be difficult to remove it from the panel.

CONNECTION DIAGRAM



ENDA EPV942 is intended for installation in control panels. Make sure that the device is used only for intended purpose. The electrical connections must be carried on by a qualified staff and must be according to the relevant locally applicable regulations. During an installation, all of the cables that are connected to the device must be free of electrical power. The device must be protected against inadmissible humidity, vibrations and severe soiling. Make sure that the operation temperature is not exceeded. The cables should not be close to the power cables or components.



If *ItYP* input type "*u500*" is selected, the measurement lines 12 and 15 of the terminals must be connected. Otherwise, measurement will be incorrect.

If *ItYP* input type "*u100*" or *uErr* is selected, the measurement lines 13 and 14 of the terminals must be connected. Otherwise, measurement will be incorrect.

NOTE :

SUPPLY:

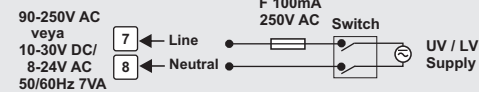

Fuse should be connected.

Cable size: 1,5mm²



- 1) Mains supply cords shall meet the requirements of IEC 60227 or IEC 60245.
- 2) In accordance with the safety regulations, the power supply switch shall bring the identification of the relevant instrument and it should be easily accessible by the operator.

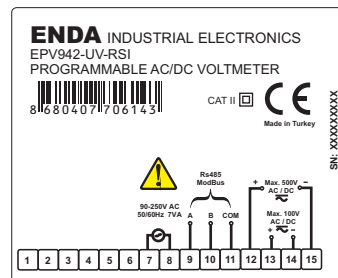
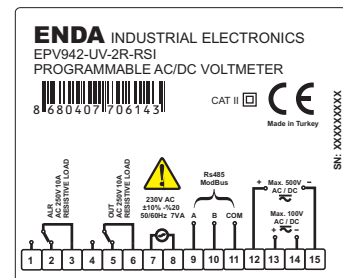

Holding screw 0,4-0,5Nm.



Equipment is protected throughout by DOUBLE INSULATION

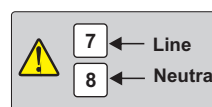

* MODBUS CONNECTION DIAGRAM

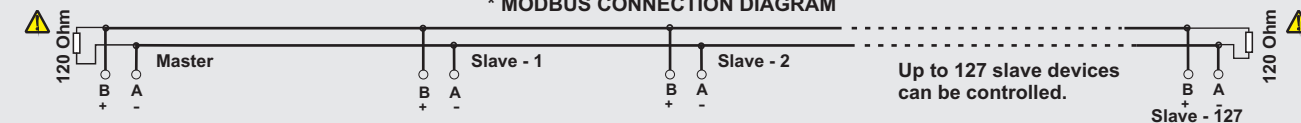

Termination should be accomplished by attaching 120 Ohm resistors to the start and at the end of the communication line.

* Applies to devices with Modbus function.

OUTPUT GRAPHICS

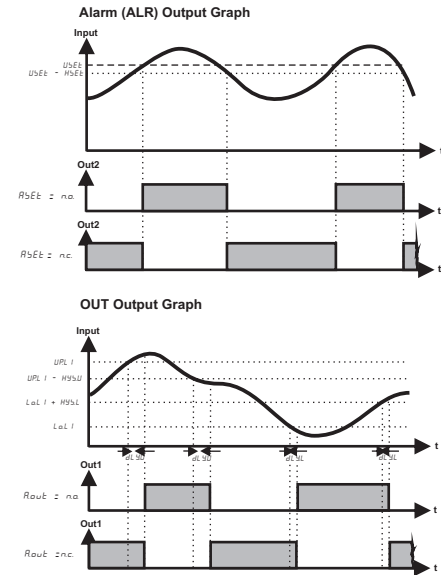

	ac	dc	Ac,dc (rms)
	$A \frac{1}{\sqrt{2}}$	0.000	$A \frac{1}{\sqrt{2}}$
	0.308 A	$A \frac{2}{\pi}$	$A \frac{1}{\sqrt{2}}$
	0.386 A	$A \frac{1}{\pi}$	$A \frac{1}{2}$
	A	0.000	A
	$A \frac{1}{2}$	$A \frac{1}{2}$	$A \frac{1}{\sqrt{2}}$
	$A \sqrt{\frac{d}{T} - \frac{d^2}{T^2}}$	$A \frac{d}{T}$	$A \sqrt{\frac{d}{T}}$
	$A \frac{1}{\sqrt{3}}$	0.000	$A \frac{1}{\sqrt{3}}$



EPV942 PROGRAMMING DIAGRAM

Increment Key		Used for increasing the setpoint value and changing parameters. When held down for a few seconds, configured numeric value increases faster.
Decrement Key		Used for decreasing the setpoint value and changing parameters. When held down for a few seconds, configured numeric value increases faster.
Programming Key		Used for displaying and configuring the selected parameter value.
Lock / Unlock Keypad		Locks / Unlocks keypad.

If these keys are pressed and held for 3 seconds, "Programming Mode" is entered or it returns to "Running Mode". If and keys are pressed while parameter names are displayed, than it returns to measured value.

PROGRAMMING MODE

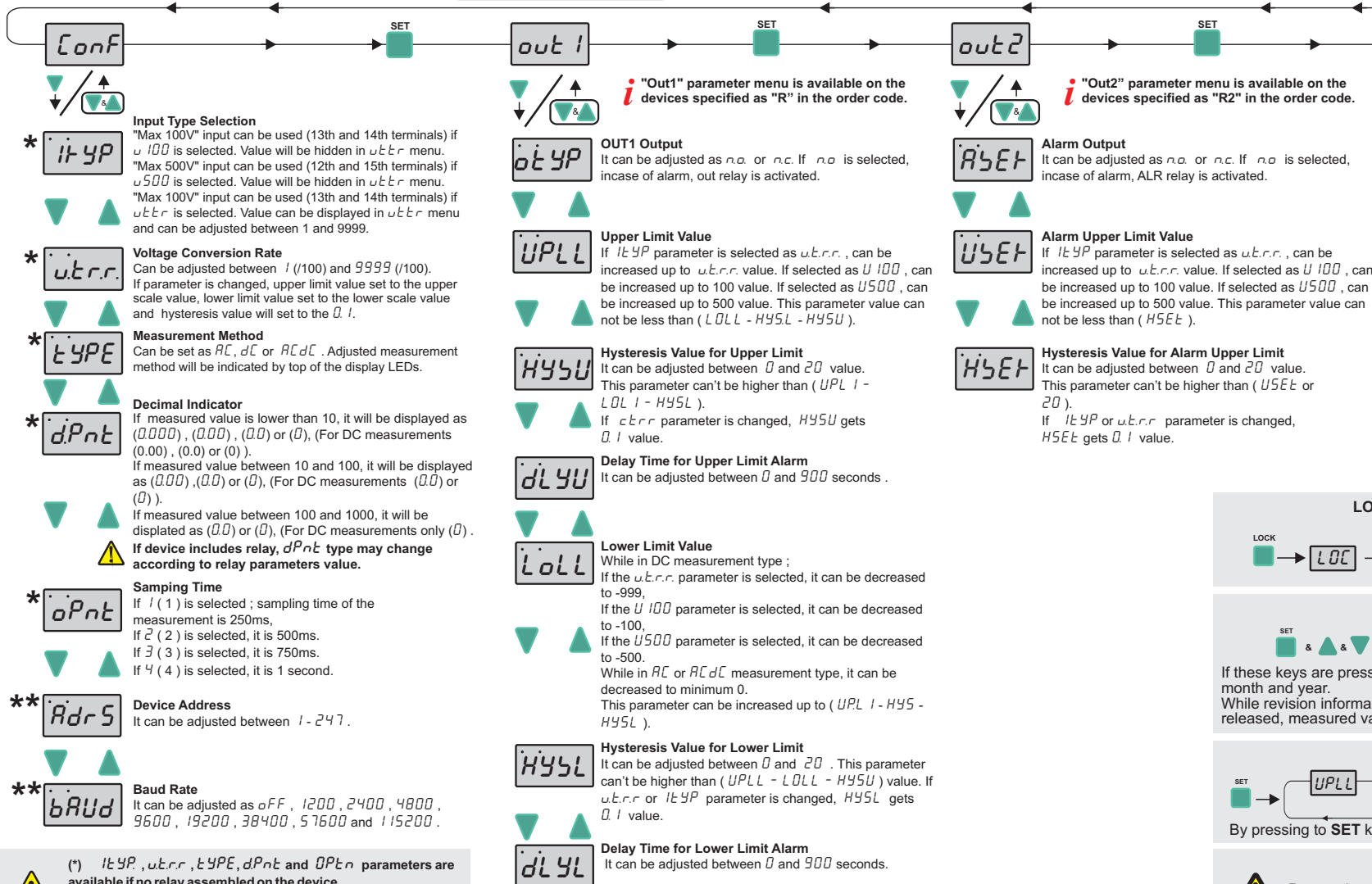

SETTING UP THE PARAMETERS



If key is pressed, the current value of the parameter appears by flashing on the display.
 By using "UP" or "DOWN" navigation keys, selected parameter can be adjusted to the desired value.
 After the setting up the parameters, if set key is pressed again, adjusted parameter name appears on display.

ERROR MESSAGES

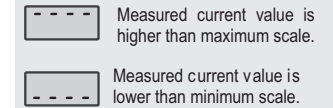

LOCKING & UNLOCKING KEYPAD

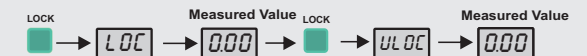

REVISION NUMBER

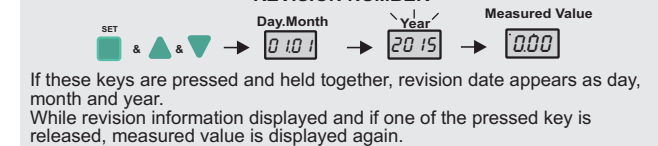

QUICK MENU

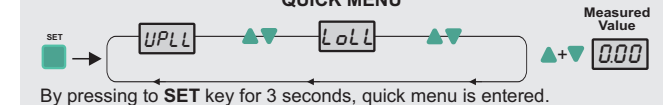

DEFAULT SETTINGS

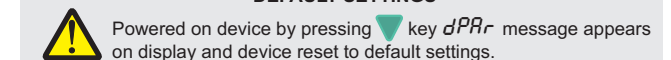

(*) *itYP*, *uErr*, *tYPE*, *dPnt* and *oPnt* parameters are available if no relay assembled on the device.
 (**) *AdrS* and *bAUD* parameters are available only with Modbus featured devices.

ENDA EPV942 DIGITAL VOLTMETER MODBUS PROTOCOL ADDRESS MAP

HOLDING REGISTERS FOR "R" EXTENSION DEVICES

Holding Register Addresses		Data Type	Data Content	Parameter Name	Read/Write Permission	Status Value
Decimal	Hex					
0000d	0x0000	word	Alarm output status	<i>0tYP</i>	Readable/Writable	<i>no</i>
0001d	0x0001	word	Input type selection	<i>itYP</i>	Readable/Writable	<i>u.t.r.r</i>
0002d	0x0002	word	Voltage Conversion Rate	<i>u.t.r.r</i>	Readable/Writable	<i>100</i>
0003d	0x0003	word	The upper limit of the setpoint	<i>UPLL</i>	Readable/Writable	<i>5000</i>
0004d	0x0004	word	The upper limit of the hysteresis value	<i>HYSU</i>	Readable/Writable	<i>10</i>
0005d	0x0005	word	Delay time for the upper limit alarm	<i>dLYU</i>	Readable/Writable	<i>0</i>
0006d	0x0006	word	The lower limit of the setpoint	<i>LDLL</i>	Readable/Writable	<i>00</i>
0007d	0x0007	word	The lower limit of the hysteresis value	<i>HYSL</i>	Readable/Writable	<i>10</i>
0008d	0x0008	word	Delay time for the lower limit alarm	<i>dLYL</i>	Readable/Writable	<i>0</i>
0009d	0x0009	word	Measurement method (0=AC, 1=dC, 2=ACdC)	<i>tYPE</i>	Readable/Writable	<i>ACdC</i>
0010d	0x000A	word	Decimal point. (0=X, 1=X.X, 2=X.XX, 3=X.XXX)	<i>dPnt</i>	Readable/Writable	<i>00</i>
0011d	0x000B	word	Sampling time of the measurement value. If 1 is selected, it is 250ms. If 2 is selected, it is 500ms. If 3 is selected, it is 750ms. If 4 is selected, it is 1 second.	<i>oPtn</i>	Readable/Writable	<i>4</i>
0012d	0x000C	word	Device address for RS485 network connection. Adjustable between 1-247.	<i>AdrS</i>	Readable/Writable	<i>1</i>
0013d	0x000D	word	Baudrate (0=Off;1=1200;2=2400; 3=4800; 4=9600; 5=19200 6= 38400; 7= 57600; 8= 115200)	<i>bAUD</i>	Readable/Writable	<i>oFF</i>

*Holding Register Parameter Table (No Relay Models)

0000d	0x0000	word	Input type selection	<i>itYP</i>	Readable/Writable	<i>u.t.r.r</i>
0001d	0x0001	word	Voltage Conversion Rate	<i>u.t.r.r</i>	Readable/Writable	<i>100</i>
0003d	0x0003	word	Measurement method (0=AC, 1=dC, 2=ACdC)	<i>tYPE</i>	Readable/Writable	<i>ACdC</i>
0004d	0x0004	word	Decimal point. (0=X.XX,1=X.X,2=X)	<i>dPnt</i>	Readable/Writable	<i>0.000</i>
0005d	0x0005	word	Sampling time of the measurement value	<i>oPtn</i>	Readable/Writable	<i>4</i>
0006d	0x0006	word	Device address for RS485 network connection. Adjustable between 1-247.	<i>AdrS</i>	Readable/Writable	<i>1</i>
0007d	0x0007	word	Baudrate (0=Off;1=1200;2=2400; 3=4800; 4=9600; 5=19200 6= 38400; 7= 57600; 8= 115200)	<i>bAUD</i>	Readable/Writable	<i>oFF</i>

INPUT REGISTERS FOR EPV942-x-xxx-RSI DEVICES

Input Register Addresses		Data Type	Data Content	Parameter Name	Read/Write Permission
Decimal	Hex				
0000d	0x0000	word	Measured voltage value	--	Only Readable

DISCRETE INPUTS FOR "R" EXTENSION DEVICES

Discrete Input Addresses		Data Type	Data Content	Parameter Name	Read/Write Permission
Decimal	Hex				
0000d	0x0000	Bit	Relay output state (0= <i>oFF</i> ; 1= <i>on</i>)	--	Only Readable

COILS FOR "R" EXTENSION DEVICES

Coil Addresses		Data Type	Data Content	Parameter Name	Read/Write Permission	Status Value
Decimal	Hex					
0000d	0x0000	Bit	Alarm output state (0= <i>no</i> ; 1= <i>nc</i>)	<i>0tYP</i>	Readable/Writable	<i>no</i>

* Coil and Discrete input parameters are not available in the devices those have no relay

Note 1 : *0tYP* menu parameters can be used as "Holding Register" or "Coil".

Note 2 : Received "ModBus input register value" is multiplying by 1000 (based on *dPnt*) and mV value reached.

For example ;

if modbus value is 2842, (for *dPnt* = 2 (0.00)) 28.42x1000 = 28420 mV, ie 28.42V

if modbus value is 2842, (for *dPnt* = 3 (0.000)) 2.842x1000 = 2842 mV, ie 2.842V

ENDA EPV942 DIGITAL VOLTMETER MODBUS PROTOCOL ADDRESS MAP

HOLDING REGISTERS FOR "R2" EXTENSION DEVICES

Holding Register Addresses		Data Type	Data Content	Parameter Name	Read/Write Permission	Status Value
Decimal	Hex					
0000d	0x0000	word	Alarm (OUT) output status	<i>0tYP</i>	Readable/Writable	<i>no</i>
0001d	0x0001	word	Alarm (ALR) output status	<i>RS5Et</i>	Readable/Writable	<i>no</i>
0002d	0x0002	word	Input type selection	<i>ItYP</i>	Readable/Writable	<i>u.t.r.r</i>
0003d	0x0003	word	Voltage Conversion Rate	<i>u.t.r.r</i>	Readable/Writable	<i>100</i>
0004d	0x0004	word	The upper limit of the setpoint	<i>UPLL</i>	Readable/Writable	<i>500.0</i>
0005d	0x0005	word	The upper limit of the hysteresis value	<i>HYSU</i>	Readable/Writable	<i>1.0</i>
0006d	0x0006	word	Delay time for the upper limit alarm	<i>dLYU</i>	Readable/Writable	<i>0</i>
0007d	0x0007	word	The lower limit of the setpoint	<i>LOLL</i>	Readable/Writable	<i>0.0</i>
0008d	0x0008	word	The lower limit of the hysteresis value	<i>HYSL</i>	Readable/Writable	<i>1.0</i>
0009d	0x0009	word	Delay time for the lower limit alarm	<i>dLYL</i>	Readable/Writable	<i>0</i>
0010d	0x000A	word	Upper limit value for alarm	<i>USEt</i>	Readable/Writable	<i>5.000</i>
0011d	0x000B	word	Hysteresis value for upper alarm limit			
0012d	0x000C	word	Measurement method (0=AC, 1=dC, 2=ACdC)	<i>tYPE</i>	Readable/Writable	<i>ACdC</i>
0013d	0x000D	word	Decimal point. (0=X, 1=X.X, 2=X.XX, 3=X.XXX)	<i>dPnt</i>	Readable/Writable	<i>0.000</i>
0014d	0x000E	word	Sampling time of the measurement value. If 1 is selected, it is 250ms. If 2 is selected, it is 500ms. If 3 is selected, it is 750ms. If 4 is selected, it is 1 second.	<i>oPtn</i>	Readable/Writable	<i>4</i>
0015d	0x000F	word	Device address for RS485 network connection. Adjustable between 1-247.	<i>AdRS</i>	Readable/Writable	<i>1</i>
0016d	0x0010	word	Baudrate (0=Off;1=1200;2=2400; 3=4800; 4=9600; 5=19200 6= 38400; 7= 57600; 8= 115200)	<i>bAUD</i>	Readable/Writable	<i>oFF</i>

INPUT REGISTERS FOR EPV942-x-xxx-RSI DEVICES

Input Register Addresses		Data Type	Data Content	Parameter Name	Read/Write Permission
Decimal	Hex				
0000d	0x0000	word	Measured voltage value	--	Only Readable

DISCRETE INPUTS FOR "R2" EXTENSION DEVICES

Discrete Input Addresses		Data Type	Data Content	Parameter Name	Read/Write Permission
Decimal	Hex				
0000d	0x0000	Bit	Relay output state (0=OFF; 1=on)	--	Only Readable

COILS FOR "R2" EXTENSION DEVICES

Coil Addresses		Data Type	Data Content	Parameter Name	Read/Write Permission	Status Value
Decimal	Hex					
0000d	0x0000	Bit	Alarm (OUT) output status (0 = no , 1 = nc)	<i>0tYP</i>	Readable/Writable	<i>no</i>
0001d	0x0001	Bit	Alarm (ALR) output status (0 = no , 1 = nc)	<i>RS5Et</i>	Readable/Writable	<i>no</i>

Note 1 : *0tYP* and *RS5Et* menu parameters can be used as "Holding Register" or "Coil."

Note 2 : Received "ModBus input register value" is multiplying by 1000 (based on *dPnt*) and mV value reached.

For example ;

if modbus value is 2842, (for *dPnt* = 2 (0.00)) 28.42x1000 = 28420 mV, ie 28.42V

if modbus value is 2842, (for *dPnt* = 3 (0.000)) 2.842x1000 = 2842 mV, ie 2.842V