



Read this document carefully before using this device. The guarantee will be expired by damaging of the device if you don't attend to the directions in the user manual. Also we don't accept any compensations for personal injury, material damage or capital disadvantages.

ENDA EPA942 PROGRAMMABLE AC/DC AMMETER

Thank you for choosing ENDA EPA942 Programmable AC/DC Ammeter.

- ▶ 96 x 96mm sized.
- ▶ 4 digits display.
- ▶ Easy to use with front panel keypad.
- ▶ Can be used with current transformer or shunt.
- ▶ Programmable scale between 5A and 9999A.
- ▶ Multi-functional alarm output for Lower and Upper limits (NO+NC).
- ▶ Multi-functional alarm setpoints with Alarm Output (NO+NC).
- ▶ Multifunctional alarm output (NO+NC) for upper and lower limits.
- ▶ Communication feature over isolated RS485, using ModBus RTU protocol.(Optional).
- ▶ Measuring type can be selected as AC, DC or true RMS.
- ▶ Key lock feature.
- ▶ CE marked according to European Norms.



R^oHS
Compliant



Order code : EPA942 -

| | | | |
|--|--|--|--|
| | | | |
|--|--|--|--|

| | | |
|--|--|---|
| 1 - Supply Voltage UV.....90-250V AC LV.....10-30V DC / 8-24V AC | 2 -Output R.....10A(Out)Relay 2R.....10A(Out+Alr)Relay | 3 - Modbus RSI...RS485 Modbus Available (Specify at Order) |
|--|--|---|

TECHNICAL SPECIFICATIONS

| ENVIRONMENTAL CONDITIONS | |
|----------------------------|--|
| Ambient/stroge temperature | 0 ... +50°C/ -25 ... 70°C |
| Max. Relative humidity | 80% Relative humidity for temperatures up to 31°C, decreasing linearly to 50% at 40°C. |
| Rated pollution degree | According to EN 60529 Front panel : IP65 , Rear panel : IP20 |
| Height | Max. 2000m |



Do not use the device in locations subject to corrosive and flammable gases.

| ELECTRICAL CHARACTERISTICS | | | | | | | |
|----------------------------|---|----|----|----|----|----|----|
| Supply | 90-250V AC 50/60Hz ; 10-30V DC / 8-24V AC SMPS | | | | | | |
| Power consumption | Max. 5VA | | | | | | |
| Wiring | 2.5mm ² screw-terminal connections | | | | | | |
| Scale | AC and RMS : 0A...9999A (Specified by c.t.r.r parameter. For example:scale is 0A...5A for c.tr.r=5.00) DC : -999A...9999A (Specified by c.tr.r parameter. For example:scale is -5A...5A for c.tr.r=5.00) | | | | | | |
| Sensitivity | 0.001A x (c.t.r.r /5) (For example , 0.001A for c.t.r.r=5.00) | | | | | | |
| Accuracy | AC : ± 1% (full scale) (± 2% For square wave form) DC : ± 1% (full scale) RMS : ± 1% (full scale) (± 2% For square wave form) | | | | | | |
| Input Range | <table border="1" style="display: inline-table; border-collapse: collapse;"><tr><td style="width: 15px; height: 15px;">13</td><td style="width: 15px; height: 15px;">14</td></tr><tr><td style="width: 15px; height: 15px;">12</td><td style="width: 15px; height: 15px;">15</td></tr></table> -5A...5A (Device may be damaged at 10A and above currents) <table border="1" style="display: inline-table; border-collapse: collapse;"><tr><td style="width: 15px; height: 15px;">12</td><td style="width: 15px; height: 15px;">15</td></tr></table> -60mV...60mV (Device may be damaged at 50V and above voltages) | 13 | 14 | 12 | 15 | 12 | 15 |
| 13 | 14 | | | | | | |
| 12 | 15 | | | | | | |
| 12 | 15 | | | | | | |
| Input Impedance | <table border="1" style="display: inline-table; border-collapse: collapse;"><tr><td style="width: 15px; height: 15px;">13</td><td style="width: 15px; height: 15px;">14</td></tr><tr><td style="width: 15px; height: 15px;">12</td><td style="width: 15px; height: 15px;">15</td></tr></table> 12mΩ <table border="1" style="display: inline-table; border-collapse: collapse;"><tr><td style="width: 15px; height: 15px;">12</td><td style="width: 15px; height: 15px;">15</td></tr></table> 40kΩ | 13 | 14 | 12 | 15 | 12 | 15 |
| 13 | 14 | | | | | | |
| 12 | 15 | | | | | | |
| 12 | 15 | | | | | | |
| Frequency Range | DC , 10Hz - 200Hz (10Hz - 70Hz For square wave form) | | | | | | |
| EMC | EN 61326-1: 2013 | | | | | | |
| Safety requirements | EN 61010-1: 2010 (Pollution degree 2, overvoltage category II) | | | | | | |

| OUTPUTS | |
|---------------------------|---|
| Output | 250V AC, 10A (for resistive load), NO+NC |
| Alarm output | 250V AC, 10A (for resistive load), NO+NC |
| Life expectancy for relay | Mechanical 30.000.000 ; Electrical 100.000 operation. |

| HOUSING | |
|--------------------|------------------------------------|
| Housing type | Suitable for flush-panel mounting. |
| Dimensions | W96xH96xD50mm |
| Weight | Approx. 410g (after packing) |
| Enclosure material | Self extinguishing plastics. |



While cleaning the device, solvents (thinner, gasoline, acid etc.) or corrosive materials must not be used.



SISEL MÜHENDİSLİK ELEKTRONİK SAN. VE TİC. A.Ş.
 Şenifali Mah. Barbaros Cad. No:18 Y.Dudullu 34775
 ÜMRANİYE/İSTANBUL-TURKEY
 Tel : +90 216 499 46 64 Pbx. Fax : +90 216 365 74 01
 url : www.enda.com.tr



DIMENSIONS



Panel Cut-out

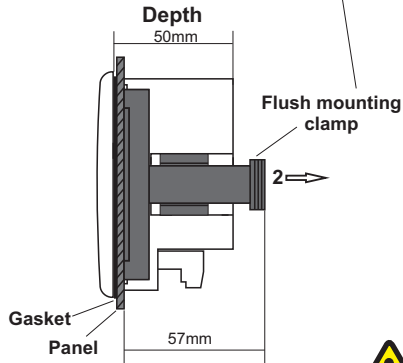
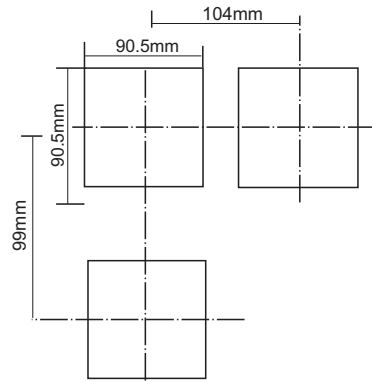

For removing mounting clamps :

- Push the flush-mounting clamp in direction 1 as shown in the figure left.
- Then, pull out the clamp in direction 2.

- 1) Panel thickness should be maximum 10mm.
- 2) There must be at least 60mm free space behind the device, otherwise it would be difficult to remove it from the panel.

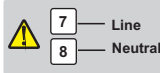

CONNECTION DIAGRAM

ENDA EPA942 is intended for installation in control panels. Make sure that the device is used only for intended purpose. The electrical connections must be carried on by a qualified staff and must be according to the relevant locally applicable regulations. During an installation, all of the cables that are connected to the device must be free of electrical power. The device must be protected against inadmissible humidity, vibrations and severe soiling. Make sure that the operation temperature is not exceeded. The cables should not be close to the power cables or



CAUTION :

If 5A and 60mV inputs are connected at the same time, the measurement will be incorrect.

NOTE :

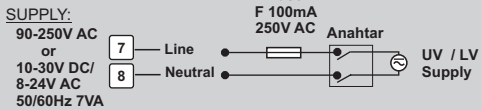

Fuse should be connected.

Cable size: 1,5mm²

- 1) Mains supply cords shall meet the requirements of IEC 60227 or IEC 60245.
- 2) In accordance with the safety regulations, the power supply switch shall bring the identification of the relevant instrument and it should be easily accessible by the operator.

ALARM OUTPUT CHART

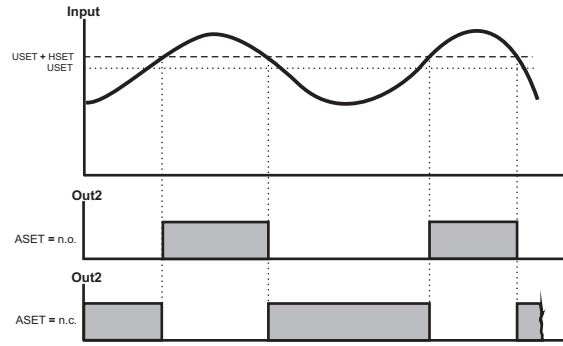

OUTPUT CHART

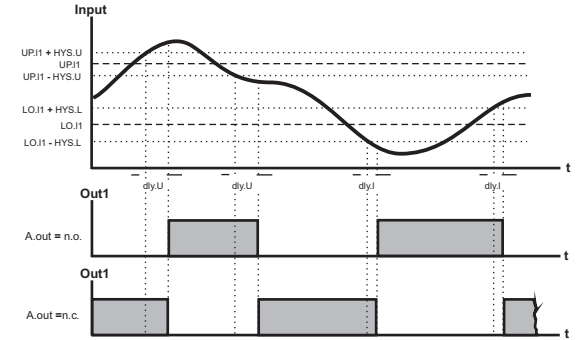

ENDA INDUSTRIAL ELECTRONICS
EPA942-UV-2R-RSI
PROGRAMMABLE AC/DC AMMETER

CAT II Made in Turkey

SN: XXXXXXXXX

ENDA INDUSTRIAL ELECTRONICS
EPA942-UV-RSI
PROGRAMMABLE AC/DC AMMETER

CAT II Made in Turkey

SN: XXXXXXXXX

| | ac | dc | Ac.dc (rms) |
|--|--|-------------------|------------------------|
| | $A \frac{1}{\sqrt{2}}$ | 0.000 | $A \frac{1}{\sqrt{2}}$ |
| | 0.308 A | $A \frac{2}{\pi}$ | $A \frac{1}{\sqrt{2}}$ |
| | 0.386 A | $A \frac{1}{\pi}$ | $A \frac{1}{2}$ |
| | A | 0.000 | A |
| | $A \frac{1}{2}$ | $A \frac{1}{2}$ | $A \frac{1}{\sqrt{2}}$ |
| | $A \sqrt{\frac{d}{T} - \frac{d^2}{T^2}}$ | $A \frac{d}{T}$ | $A \sqrt{\frac{d}{T}}$ |
| | $A \frac{1}{\sqrt{3}}$ | 0.000 | $A \frac{1}{\sqrt{3}}$ |

Equipment is protected throughout by DOUBLE INSULATION

Holding screw 0.4-0.5Nm.



EPA942 PROGRAMMING DIAGRAM

| | | |
|-----------------------------|--|--|
| Incrment Key | | Used for increasing the setpoint value and changing parameters. When held down for a few seconds, configured numeric value increases faster. |
| Decrement Key | | Used for decreasing the setpoint value and changing parameters. When held down for a few seconds, configured numeric value increases faster. |
| Programming Key | | Used for displaying and configuring the selected parameter value. |
| Lock / Unlock Keypad | | Locks / Unlocks keypad. |

SETTING UP THE PARAMETERS

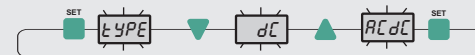

- If key is pressed, the current value of the parameter appears by flashing on the display.
- By using "UP" or "DOWN" navigation keys, selected parameter can be adjusted to the desired value.
- After the setting up the parameters, if set key is pressed again, adjusted parameter name appears on display.

If these keys are pressed and held for 3 seconds, "Programming Mode" is entered or it returns to "Running Mode".
 If and keys are pressed while parameter names are displayed, than it returns to measured value.

PROGRAMMING MODE

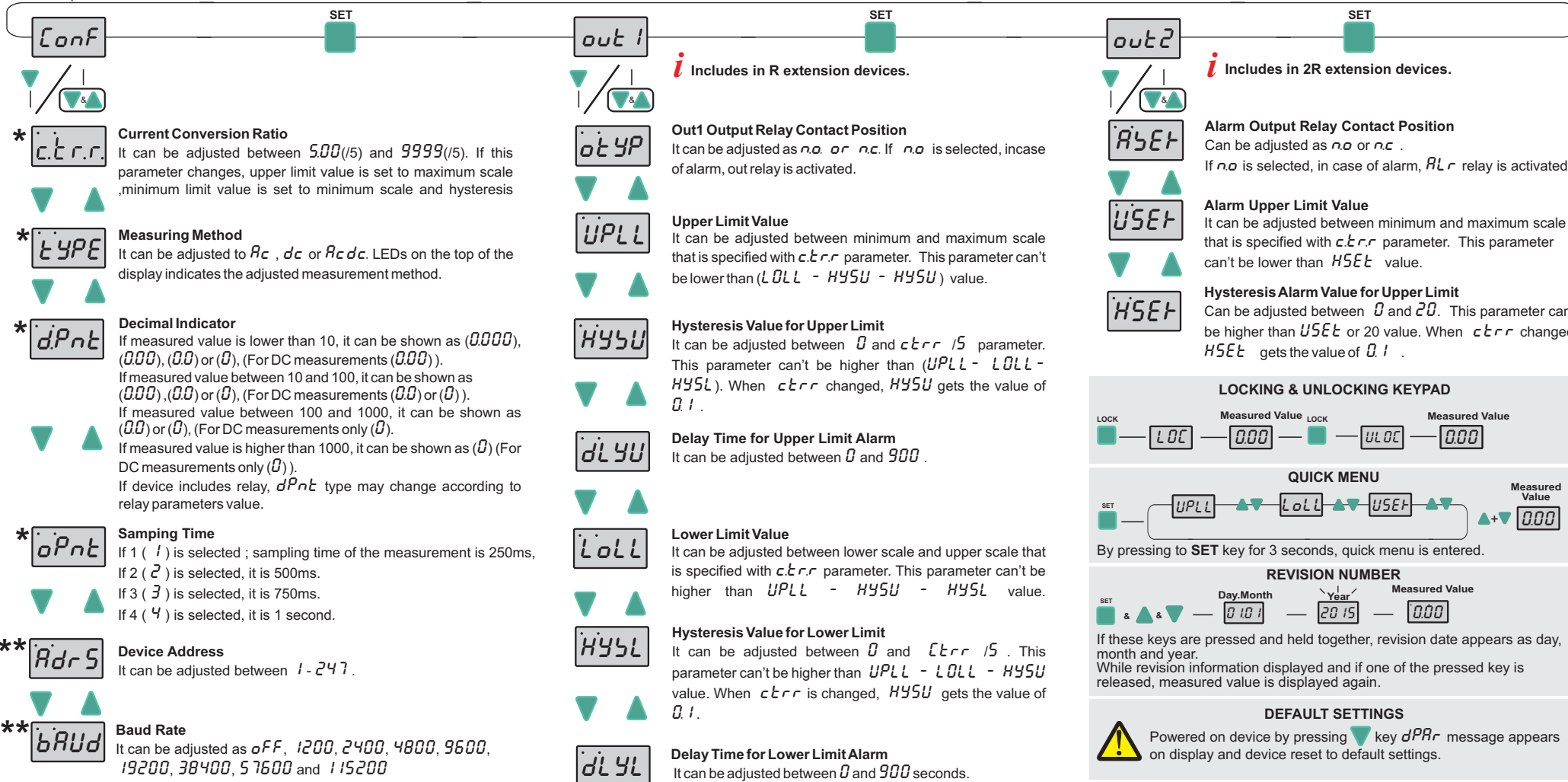

LOCKING & UNLOCKING KEYPAD

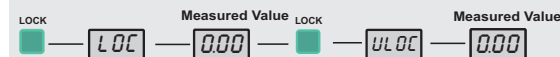

QUICK MENU

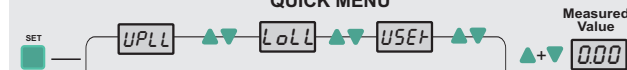

By pressing to **SET** key for 3 seconds, quick menu is entered.

REVISION NUMBER

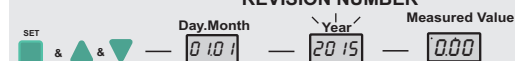

If these keys are pressed and held together, revision date appears as day, month and year. While revision information displayed and if one of the pressed key is released, measured value is displayed again.

DEFAULT SETTINGS

Powered on device by pressing key *dPnt* message appears on display and device reset to default settings.

ERROR MESSAGES

Measured current value is higher than maximum scale.

Measured current value is lower than minimum scale.

(*) *cErr*, *tYPE*, *dPnt* and *oPnt* parameters are available for only that devices have no relays.

(**) *AdrS* and *bAUd* parameters are available for only that devices have ModBus.

ENDA EPA942 DIGITAL AMPERMETER MODBUS PROTOCOL ADDRESS MAP

HOLDING REGISTERS FOR R EXTENSION DEVICES

| Holding Register Addresses | | Data Type | Data Content | Parameter Name | Read/Write Permission | Status Value |
|----------------------------|--------|-----------|--|----------------|-----------------------|--------------|
| Decimal | Hex | | | | | |
| 0000d | 0x0000 | word | Alarm Output Relay Contact Position | <i>DTYP</i> | Readable/Writable | <i>no</i> |
| 0001d | 0x0001 | word | Current change ratio. | <i>ctrr</i> | Readable/Writable | <i>5</i> |
| 0002d | 0x0002 | word | The upper limit of the setpoint | <i>UPLL</i> | Readable/Writable | <i>5.000</i> |
| 0003d | 0x0003 | word | The upper limit of the hysteresis value | <i>HYSU</i> | Readable/Writable | <i>0.100</i> |
| 0004d | 0x0004 | word | Delay time for the upper limit alarm | <i>dLYU</i> | Readable/Writable | <i>0</i> |
| 0005d | 0x0005 | word | The lower limit of the setpoint | <i>LOLL</i> | Readable/Writable | <i>0.000</i> |
| 0006d | 0x0006 | word | The lower limit of the hysteresis value | <i>HYSL</i> | Readable/Writable | <i>0.100</i> |
| 0007d | 0x0007 | word | Delay time for the lower limit alarm | <i>dLYL</i> | Readable/Writable | <i>0</i> |
| 0008d | 0x0008 | word | Measurement method (<i>0=AC, 1=dC, 2=ACdC</i>) | <i>TYPE</i> | Readable/Writable | <i>ACdC</i> |
| 0009d | 0x0009 | word | Decimal point. (<i>0=X, 1=X.X, 2=X.XX, 3=X.XXX</i>) | <i>dPnt</i> | Readable/Writable | <i>0.000</i> |
| 0010d | 0x000A | word | Sampling time of the measurement value. If 1 is selected, it is 250ms. If 2 is selected, it is 500ms. If 3 is selected, it is 750ms. If 4 is selected, it is 1 second. | <i>oPtn</i> | Readable/Writable | <i>4</i> |
| 0011d | 0x000B | word | Device address for RS485 network connection. Adjustable between 1-247. | <i>Adrs</i> | Readable/Writable | <i>1</i> |
| 0012d | 0x000C | word | Baudrate (<i>0=Off; 1=1200; 2=2400; 3=4800; 4=9600; 5=19200; 6= 38400; 7= 57600; 8= 115200</i>) | <i>bAUD</i> | Readable/Writable | <i>oFF</i> |

*HOLDING REGISTER PARAMETER TABLE (NO RELAY MODELS)

| | | | | | | |
|-------|--------|------|---|-------------|-------------------|-------------|
| 0000d | 0x0000 | word | Current change ratio. | <i>ctrr</i> | Readable/Writable | <i>5</i> |
| 0001d | 0x0001 | word | Measurement method (<i>0=AC, 1=dC, 2=ACdC</i>) | <i>TYPE</i> | Readable/Writable | <i>ACdC</i> |
| 0002d | 0x0002 | word | Decimal point. (<i>0=X.XX, 1=X.X, 2=X</i>) | <i>dPnt</i> | Readable/Writable | <i>0.00</i> |
| 0003d | 0x0003 | word | Sampling time of the measurement value | <i>oPtn</i> | Readable/Writable | <i>4</i> |
| 0004d | 0x0004 | word | Device address for RS485 network connection. Adjustable between 1-247. | <i>Adrs</i> | Readable/Writable | <i>1</i> |
| 0005d | 0x0005 | word | Baudrate (<i>0=Off; 1=1200; 2=2400; 3=4800; 4=9600; 5=19200; 6= 38400; 7= 57600; 8= 115200</i>) | <i>bAUD</i> | Readable/Writable | <i>oFF</i> |

INPUT REGISTERS FOR R EXTENSION DEVICES

| Input Register Addresses | | Data Type | Data Content | Parameter Name | Read/Write Permission |
|--------------------------|--------|-----------|------------------------|----------------|-----------------------|
| Decimal | Hex | | | | |
| 0000d | 0x0000 | word | Measured current value | -- | Only Readable |

DISCRETE INPUTS FOR R EXTENSION DEVICES

| Discrete Input Addresses | | Data Type | Data Content | Parameter Name | Read/Write Permission |
|--------------------------|--------|-----------|---|----------------|-----------------------|
| Decimal | Hex | | | | |
| 0000d | 0x0000 | Bit | Relay output state (<i>0=oFF; 1=on</i>) | -- | Only Readable |

COILS FOR R EXTENSION DEVICES

| Coil Addresses | | Data Type | Data Content | Parameter Name | Read/Write Permission | Status Value |
|----------------|--------|-----------|---|----------------|-----------------------|--------------|
| Decimal | Hex | | | | | |
| 0000d | 0x0000 | Bit | Out1 Output Relay Contact Position (<i>0=no; 1=nc</i>) | <i>DTYP</i> | Readable/Writable | <i>no</i> |
| 0001d | 0x0001 | Bit | Alarm Output Relay Contact Position (<i>0=no; 1=nc</i>) | <i>RSEt</i> | Readable/Writable | <i>no</i> |

* Coil and Discrete input parameters are not available that devices have no relays.

Note 1 : *DTYP* and *RSEt* menu parameters can be used as "Holding Register" or "Coil".

Note 2 : Received "ModBus input register value" is multiplying by 1000 (based on *dPnt*) and mA value reached. For example ;

if modbus value is 2842, (for *dPnt* = 2 (*0.00*)) $28.42 \times 1000 = 28420$ mA, ie 28.42A

if modbus value is 2842, (for *dPnt* = 3 (*0.000*)) $2.842 \times 1000 = 2842$ mA, ie 2.842A



ENDA EPA542-xx-x-xxx-RSI INPUT REGISTERS DEVICES

| Holding Register Addresses | | Data Type | Data Content | Parameter Name | Read/Write Permission | Status Value |
|----------------------------|--------|-----------|--|----------------|-----------------------|--------------|
| Decimal | Hex | | | | | |
| 0000d | 0x0000 | word | Alarm Output (OUT) Relay Contact Position | <i>OUTYP</i> | Readable/Writable | <i>no</i> |
| 0001d | 0x0001 | word | Alarm Output (OUT) Relay Contact Position | <i>ASET</i> | Readable/Writable | <i>no</i> |
| 0002d | 0x0002 | word | Current change ratio. | <i>CTRR</i> | Readable/Writable | <i>5</i> |
| 0003d | 0x0003 | word | The upper limit of the setpoint | <i>UPLL</i> | Readable/Writable | <i>5.000</i> |
| 0004d | 0x0004 | word | The upper limit of the hysteresis value | <i>HYSU</i> | Readable/Writable | <i>0.100</i> |
| 0005d | 0x0005 | word | Delay time for the upper limit alarm | <i>DLYU</i> | Readable/Writable | <i>0</i> |
| 0006d | 0x0006 | word | The lower limit of the setpoint | <i>LOLL</i> | Readable/Writable | <i>0.000</i> |
| 0007d | 0x0007 | word | The lower limit of the hysteresis value | <i>HYSL</i> | Readable/Writable | <i>0.100</i> |
| 0008d | 0x0008 | word | Delay time for the lower limit alarm | <i>DLYL</i> | Readable/Writable | <i>0</i> |
| 0009d | 0x0009 | word | Alarm Upper Limit Value | <i>USEL</i> | Readable/Writable | <i>5.000</i> |
| 0010d | 0x000A | word | Hysteresis Alarm Value for Upper Limit | <i>HSEL</i> | Readable/Writable | <i>0.100</i> |
| 0011d | 0x000B | word | Measurement method (0=AC, 1=DC, 2=ACDC) | <i>TYPE</i> | Readable/Writable | <i>ACDC</i> |
| 0012d | 0x000C | word | Decimal point. (0=X, 1=X.X, 2=X.XX, 3=X.XXX) | <i>dPnt</i> | Readable/Writable | <i>0.000</i> |
| 0013d | 0x000D | word | Measurement period. If 1 is selected, it is 250ms. If 2 is selected, it is 500ms. If 3 is selected, it is 750ms. If 4 is selected, it is 1 second. | <i>oPtn</i> | Readable/Writable | <i>4</i> |
| 0014d | 0x000E | word | Device address for RS485 network connection. Adjustable between 1-247. | <i>Adr5</i> | Readable/Writable | <i>1</i> |
| 0015d | 0x000F | word | Baudrate (0=Off;1=1200;2=2400; 3=4800; 4=9600; 5=19200 6= 38400; 7= 57600; 8= 115200) | <i>baud</i> | Readable/Writable | <i>oFF</i> |

INPUT REGISTERS FOR 2R EXTENSION DEVICES

| Input Register Addresses | | Data Type | Data Content | Parameter Name | Read/Write Permission |
|--------------------------|--------|-----------|------------------------|----------------|-----------------------|
| Decimal | Hex | | | | |
| 0000d | 0x0000 | word | Measured current value | -- | Only Readable |

DISCRETE INPUTS FOR 2R EXTENSION DEVICES

| Discrete Input Addresses | | Data Type | Data Content | Parameter Name | Read/Write Permission |
|--------------------------|--------|-----------|----------------------------------|----------------|-----------------------|
| Decimal | Hex | | | | |
| 0000d | 0x0000 | Bit | Relay output state (0=OFF; 1=on) | -- | Only Readable |

COILS FOR 2R EXTENSION DEVICES

| Coil Addresses | | Data Type | Data Content | Parameter Name | Read/Write Permission | Status Value |
|----------------|--------|-----------|--|----------------|-----------------------|--------------|
| Decimal | Hex | | | | | |
| 0000d | 0x0000 | Bit | Out1 Output Relay Contact Position (0=no; 1=nc) | <i>OUTYP</i> | Readable/Writable | <i>no</i> |
| 0001d | 0x0001 | Bit | Alarm Output Relay Contact Position (0=no; 1=nc) | <i>ASET</i> | Readable/Writable | <i>no</i> |

Note 1 : *OUTYP* and *ASET* menu parameters can be used as “Holding Register” or “Coil”.

Note 2 : Received "ModBus input register value" is multiplying by 1000 (based on *d.Pnt*) and mA value reached. For example ;

if modbus value is 2842, (for *d.Pnt* = 2 (0.00)) 28.42x1000 = 28420 mA, ie 28.42A

if modbus value is 2842, (for *d.Pnt* = 3 (0.000)) 2.842x1000 = 2842 mA, ie 2.842A