



Read this document carefully before using this device. The guarantee will be expired by device damages if you don't attend to the directions in the user manual. Also we don't accept any compensations for personal injury, material damage or capital

## ENDA EI SERIES PROGRAMMABLE INDICATOR

Thank you for choosing **ENDA EI SERIES INDICATOR**.

- ▶ 35 x 77mm and 72x72mm sized.
- ▶ 4 digits display.
- ▶ Display scale can be adjusted between -1999 and 4000.
- ▶ Decimal point can be adjusted between 1st. and 3rd. digits.
- ▶ Measurement unit can be displayed.
- ▶ Selectable four different standard input types (0-20mA, 4-20mA, 0-1V, 0-10V).
- ▶ User can calibrate the device according to specified input type.
- ▶ Sampling time can be adjusted in four steps.
- ▶ Stores maximum and minimum measurement values.
- ▶ Maximum and minimum values can be stored and displayed.
- ▶ Two relay output for control and alarm (Optional).
- ▶ Control option below and above set value.
- ▶ Selectable independent, deviation and band alarm.
- ▶ Sensor supply output (Optional).
- ▶ RS485 Modbus RTU communication protocol feature (Optional).
- ▶ CE marked according to European standards.



**RoHS**  
**Compliant**

**CE**



Order Code : EI - [ ] - [ ] - [ ] - [ ] - [ ]				
1 - Size				
2041.....37x77				
7041.....72x72				
2 - Supply Voltage		3 - Relay Output		5 - Sensor Supply
UV.....90-250V AC	2R.....OUT and ALARM	4 - Modbus		12....12V DC 50mA
LV.....10-30V DC / 8-24V AC		RS....Modbus (Specify at order)		24....24V DC 50mA

### TECHNICAL SPECIFICATIONS

ENVIRONMENTAL CONDITIONS	
Ambient/storage temperature	0 ... +50°C/-25 ... +70°C (with no icing).
Max. relative humidity	80% Relative humidity for temperatures up to 31°C, decreasing linearly to 50% at 40°C.
Rated pollution degree	According to EN 60529 Front panel : IP65 Rear panel : IP20
Height	Max. 2000mm.

**⚠ Do not use the device in locations subject to corrosive and flammable gases.**

ELECTRICAL CHARACTERISTICS	
Supply	90-250V AC 50-60Hz; 10-30V DC / 8-24V AC SMPS
Power consumption	Max. 7VA.
Wiring	2.5mm <sup>2</sup> screw-terminal connections.
Date retention	EEPROM (Min. 10 years).
EMC	EN 61326-1: 2013.
Safety requirements	EN 61010-1: 2010 (Pollution degree 2, overvoltage category II, measurement category I).
<b>⚠ EI Series cannot be used if measurement category II, III or IV is required.</b>	

Input type	Measurement range		Measurement accuracy	Input impedance
	Min.	Max.		
0-1V DC voltage	0V	1.1V	±0,5% (of full scale)	Approx. 100kΩ
0-10V DC voltage	0V	12V	±0,5% (of full scale)	Approx. 100kΩ
0-20mA DC current	0mA	25mA	±0,5% (of full scale)	Approx. 10Ω
4-20mA DC current	0mA	25mA	±0,5% (of full scale)	Approx. 10Ω

**⚠ While the current measuring mode, input impedance becomes 10Ω . Therefore, in current mode, the device must not be connected any voltage input. Otherwise, the device is broken. While the device is running in the voltage measurement mode and if required to change to current measurement mode, then firstly the voltage inputs must be removed and after that, input type must be changed to one of the current measurement modes.**

OUTPUTS	
Sensor power supply	All sensor supply outputs maximum 50 mA. (Regulated and isolated).
Out	Relay: 250V AC, 8A (for resistive load), NO; 1/2 HP 240V AC CosF = 0.4 (for inductive load).
Alarm	Relay: 250V AC, 8A (for resistive load), NO; 1/2 HP 240V AC CosF = 0.4 (for inductive load).
Life expectancy for relay	Mechanical 30.000.000 operation; 100.000 operation at 250V AC, 8A resistive load.

CONTROL	
Control type	Double set-point and alarm control.
Control algorithm	On-Off control.
Hysteresis	Adjustable between 1 ... 200.

HOUSING	
Housing type	Suitable for flush-panel mounting according to DIN 43 700.
Dimensions	EI2041 : W77xH35xD71mm, EI7041 : W72xH72xD97mm
Weight	Approx. 350g (after packaging)
Enclosure material	Self extinguishing plastics.

**⚠ While cleaning the device, solvents (thinner, gasoline, acid etc.) or corrosive materials must not be used.**



SİSEL MÜHENDİSLİK ELEKTRONİK SAN. VE TİC. A.Ş.  
Şerifali Mah. Barbaros Cad. No:18 Y.Dudullu 34775  
UMRANIYE/İSTANBUL-TURKEY  
Tel : +90 216 499 46 64 Pbx. Fax : +90 216 365 74 01  
url : www.enda.com.tr



Elx41-EN-05-221007

## FRONT PANEL

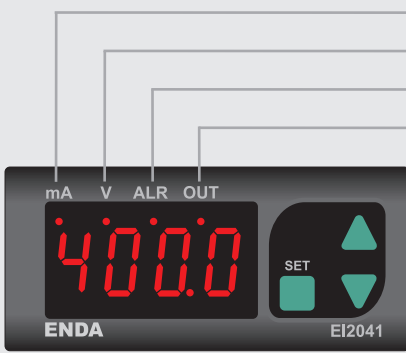

- mA LED** : If input type is selected as 0-20mA or 4-20mA, **mA LED** lights up.
- V LED** : If input type is selected as 0-1V or 0-10V, **V LED** lights up.
- ALR LED** : If alarm output is active, **ALR LED** lights up. During delay time, LED flashes.
- OUT LED** : If "OUT" is active, **OUT LED** lights up. During delay time, LED flashes.
- SET** In "Running Mode", indicates output set value.  
In "Programming Mode", indicates the selected parameter value.
- ▲** In "Running Mode", indicates the maximum measured value.  
Used for incrementing values in "Programming Mode".
- ▼** In "Running Mode", indicates the minimum measured value.  
Used for decrementing values in "Programming Mode".



- mA LED** : If input type is selected as 0-20mA or 4-20mA, **mA LED** lights up.
- V LED** : If input type is selected as 0-1V or 0-10V, **V LED** lights up.
- ALR LED** : If alarm output is active, **ALR LED** lights up. During delay time, LED flashes.
- OUT LED** : If "OUT" is active, **OUT LED** lights up. During delay time, LED flashes.
- In "Running Mode", indicates the maximum measured value.  
Used for incrementing values in "Programming Mode".
- In "Running Mode", indicates the minimum measured value.  
Used for decrementing values in "Programming Mode".
- In "Running Mode", indicates the alarm set value
- In "Running Mode", indicates output set value.  
In "Programming Mode", indicates the selected parameter value.

## DIMENSIONS

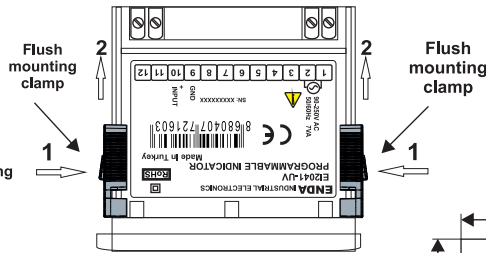
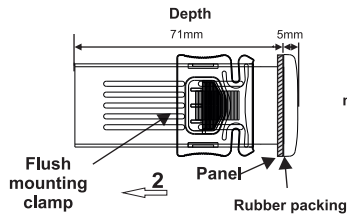

### To removing the mounting clamps :

- Push the flush-mounting clamps in direction 1
- Pull out the clamps in direction 2.

### Note :

- 1) While panel mounting, additional distance required for connection cables should be

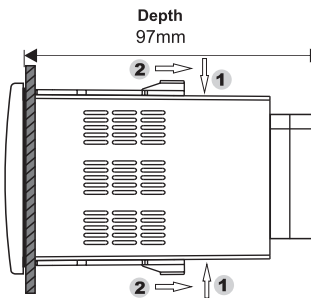

### To removing the device from the panel:

- Push the flush-mounting clamps in

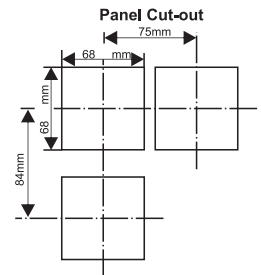
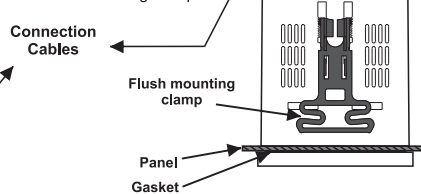

### Note :

- 1) While panel mounting, additional distance required for connection cables should be considered.
- 2) Panel thickness should be maximum 10mm.
- 3) If there is no 90mm free space at back side of the device, it would be difficult to remove it from the panel.

## CONNECTION DIAGRAM



**ENDA SERIES** is intended for installation in control panels. Make sure that the device is used only for intended purpose. The shielding must be grounded on the instrument side. During an installation, all of the cables that are connected to the device must be free of energy. The device must be protected against inadmissible humidity, vibrations, severe soiling. Make sure that the operation temperature is not exceeded. All input and output lines that are not connected to the supply network must be laid out as shielded and twisted cables. These cables should not be close to the power cables or components. The installation and electrical connections must be carried on by a qualified staff and must be according to the relevant locally applicable regulations.

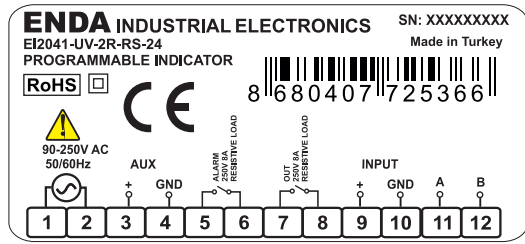

Equipment is protected throughout by **DOUBLE INSULATION**

Holding screw 0.4-0.5Nm.

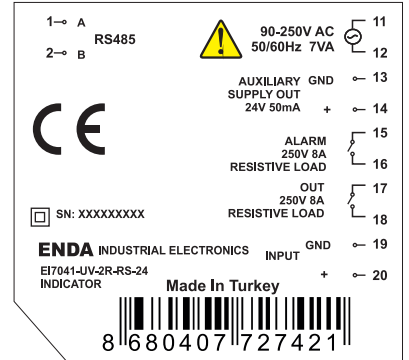

- 1) Mains supply cords shall meet the requirements of IEC 60227 or IEC 60245.
- 2) In accordance with the safety regulations, the power supply switch shall bring the identification of the relevant instrument and it should be easily accessible by the operator.



### NOTE :

#### SUPPLY :

90-250V AC  
 10-30V DC /  
 8-24V AC  
 50-60Hz 7VA

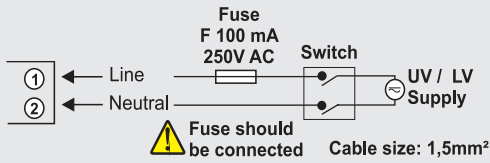

### NOTE :

#### SUPPLY :

90-250V AC  
 10-30V DC /  
 8-24V AC  
 50-60Hz 7VA

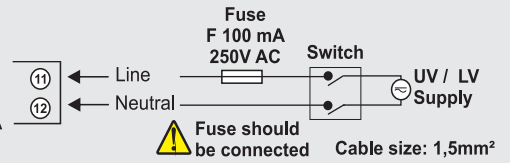

## EI2041 PROGRAMMING DEVICE

### Displaying the Measurement Unit



In "Running Mode", if **SET** **UP** keys are pressed together for 3 seconds, measurement unit appears. See *Unit* parameter for programming.

### Displaying the Minimum Measurement Unit



In "Running Mode", if **DOWN** key is pressed for 3 seconds, minimum measurement value appears.

### Displaying the Maximum Measurement Unit



In "Running Mode", if **UP** key is pressed for 3 seconds, maximum measurement value appears.

### Resetting Maximum and Minimum Measurement Values



In "Running Mode", if **SET** key pressed for 2 seconds, maximum and minimum measurement values become equal to the measured value at current time and the **rES** message appears on display.

### Locking and Unlocking

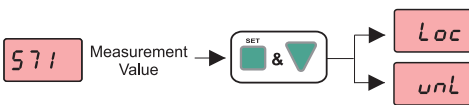

Keys are locked. If **SET** **DOWN** keys are pressed together for 2 seconds, **Loc** message appears and keys are locked. For unlocking, **SET** **DOWN** keys are pressed together for 2 seconds, **unL** message appears and keys are unlocked. If one of the keys is pressed while the device locked, **Loc** message appears on display.

### Setting Up User Calibration Values

No calibration required if the standard inputs (0-20mA, 4-20mA, 0-1V and 0-10V) are used. *CLL* Parameter should be set as *U.inP* if no standard input used. In user menu, if **UP** key is pressed for 7 seconds, **L.inP** message appears on display and calibration menu is entered.

Voltage or current which are corresponds to *L.SCL* parameter is applied to device input and **SET** key is pressed. If operation is success, **Succ** message appears on display and proceeding to the next step.

In this step, while **H.inP** message displayed, voltage or current which are corresponds to *L.SCL* parameter is applied to device input and **SET** key is pressed. If operation is success, **Succ** then **CLEnd** message appears on display, calibration process is completed and the device will start running according to the new calibration values.

### ERROR MESSAGES & DESCRIPTIONS

Error conditions and descriptions are listed below.

\* If voltage or current is difference and lower than half of full scale between *H.inP* and *L.inP* voltage or current.

\* If excessive high-low input current or voltage is applied.

\* If an error occurs during *L.inP* calibration, **Err 1** message appears on display.

\* If an error occurs during *H.inP* calibration, **Err 2** and **CLErr** message appears on display.

\* If user calibration is **not applied** before and an error occurs during calibration process, device runs according to standard calibration values.

\* If user calibration is **applied** before and an error occurs during calibration process, device runs according to previous user calibration values.

## Changing Parameters

If keys are pressed together for 2 seconds,  $P$  message appears and user menu entered. Then in user menu, first parameter's is displayed. When a parameter selected, if key is pressed selected parameter value appears and displayed parameter can be changed by keys. If no operation is performed for 3 seconds after the parameter value is being displayed or key is pressed, parameter name will be shown again. While parameter name displayed, keys are pressed together, returned to "Running Mode" without waiting period.

## Programming Mode

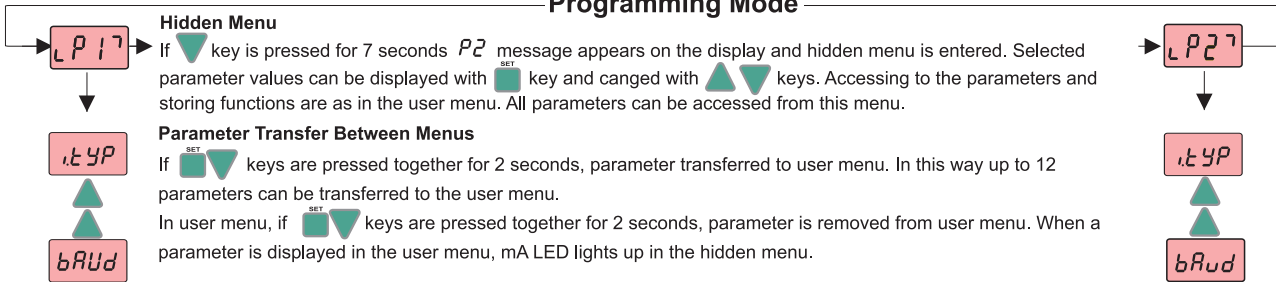

## Setting Up Measurement Unit ( $Un\ t$ ) Parameters

If pressed key in  $Un\ t$  parameter, related digit blinks on display. For desired number, letter or symbol is adjusted by pressing the key for related digit. For setting up other digits key is pressed. When parameter setting process is completed, by pressing key or no key is pressed for 3 seconds without pressing any key, parameters can be saved.

### Factory Defaults

Key is held down while the device is powered up,  $dPRr$  message will see and restore the factory parameters

### Viewing the Revision

In "Running Mode", if keys are pressed together for 3 seconds,  $r.001$  revision information appears on display.

## Running Mode Error Messages

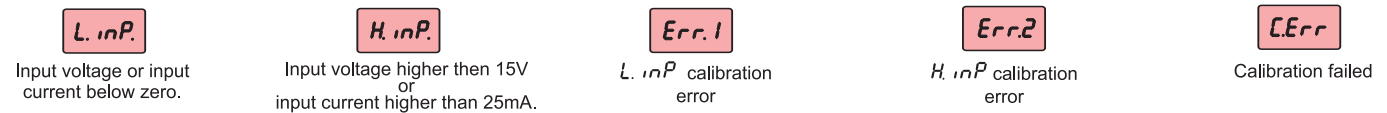

## EI7041 PROGRAMMING DEVICE

### Displaying the Measurement Unit



In "Running Mode", if keys are pressed together for 3 seconds, measurement unit appears. See  $Un\ t$  parameter for programming.

### Displaying the Minimum Measurement Unit



In "Running Mode", if key is pressed for 3 seconds, minimum measurement value appears.

### Displaying the Maximum Measurement Unit



In "Running Mode", if key is pressed for 3 seconds, maximum measurement value appears.

### Resetting Maximum and Minimum Measurement Values

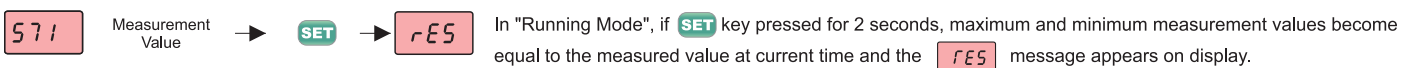

### Locking and Unlocking Keypad

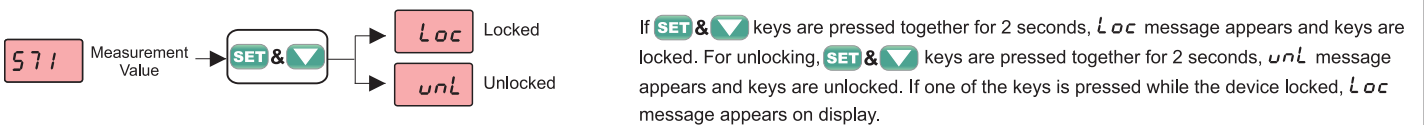

### Setting Up User Calibration Values

No calibration required if the standard inputs (0-20mA, 4-20mA, 0-1V and 0-10V) are used.  $CLt$  Parameter should be set as  $U.inP$  if no standard input used. In user menu, if key is pressed for 7 seconds,  $L.inP$  message appears on display and calibration menu is entered.

Voltage or current which are corresponds to  $LSCl$  parameter is applied to device input and key is pressed. If operation is success,  $Succ$  message appears on display and proceeding to the next step.

In this step, while  $H.inP$  message displayed, voltage or current which are corresponds to  $LSCl$  parameter is applied to device input and key is pressed. If operation is success,  $Succ$  then  $CLnd$  message appears on display, calibration process is completed and the device will start running according to the new calibration values.

### ERROR MESSAGES & DESCRIPTIONS

Error conditions and descriptions are listed below.

- \* If voltage or current is difference and lower than half of full scale between  $H.inP$  and  $L.inP$  voltage or current.
- \* If excessive high-low input current or voltage is applied.
- \* If an error occurs during  $L.inP$  calibration,  $Err\ 1$  message appears on display.
- \* If an error occurs during  $H.inP$  calibration,  $Err\ 2$  and  $C.Err$  message appears on display.
- \* If user calibration is **not applied** before and an error occurs during calibration process, device runs according to standard calibration values.
- \* If user calibration is **applied** before and an error occurs during calibration process, device runs according to previous user calibration values.

## Changing Parameters

If keys are pressed together for 2 seconds,  $P1$  message appears and user menu entered. Then in user menu, first parameter's is displayed. When a parameter selected, if **SET** key is pressed selected parameter value appears and displayed parameter can be changed by keys. If no operation is performed for 3 seconds after the parameter value is being displayed or **SET** key is pressed, parameter name will be shown again. While parameter name displayed, keys are pressed together, returned to "Running Mode" without waiting period.

## Programming Mode

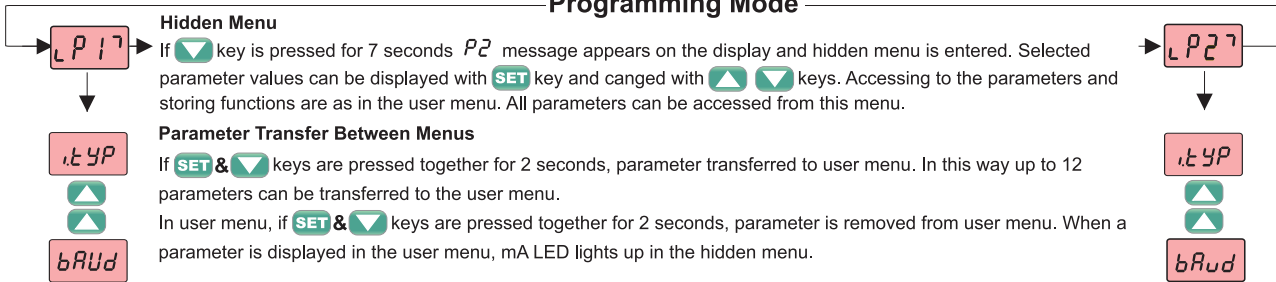

## Setting Up Measurement Unit ( $Un$ $it$ ) Parameters

If pressed **SET** key in  $Un$   $it$  parameter, related digit blinks on display. For desired number, letter or symbol is adjusted by pressing the key for related digit. For setting up other digits key is pressed. When parameter setting process is completed, by pressing **SET** key or no key is pressed for 3 seconds without pressing any key, parameters can be saved.

### Factory Defaults

Key is held down while the device is powered up,  $dPRr$  message will see and restore the factory parameters

### Viewing the Revision

In "Running Mode", if **SET** & & keys are pressed together for 3 seconds,  $r.001$  revision information appears on display.

## Running Mode Error Messages

$L.inP$

Input voltage or input current below zero.

$H.inP$

Input voltage higher then 15V or input current higher than 25mA.

$Err.1$

$L.inP$  calibration error

$Err.2$

$H.inP$  calibration error

$CErr$

Calibration failed

## OUTPUT CONDITION

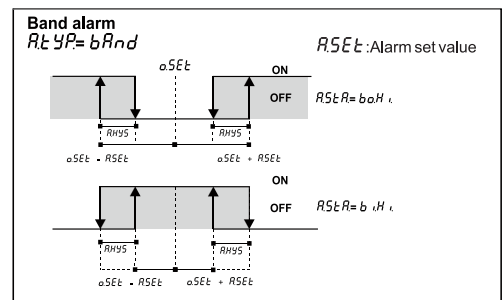
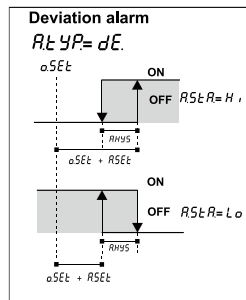
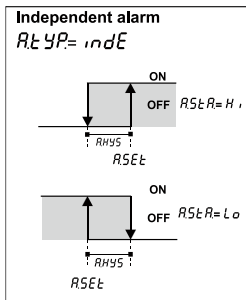
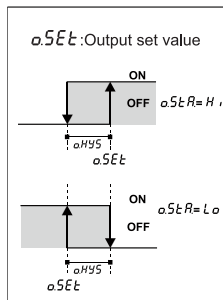

## ALARM CONDITIONS

## PARAMETER LIST

### CONFIGURATION PARAMETERS

Parameter	Description	Initial Value
$tYP$	Input type selection. (0-20mA, 4-20mA, 0-1V, 0-10V)	0-10
$dSPc$	Indicator configuration. ( $Prc5$ : Process value, $PrcUn$ : 4 Seconds process value, 2 Seconds $Un$ $it$ value.)	$Prc5$
$rRtE$	Measurement ranges. $FRSE$ : Average of 1 measurement value is gathered in 200msec. $SLo1$ : Average of 4 measurement value is gathered in 200msec. $SLo2$ : Average of 8 measurement value is gathered in 200msec. $SLo3$ : Average of 16 measurement value is gathered in 200msec.	$SLo1$
$HoLd$	Indicator holding parameter. ( $nonE$ : instant measurement value, $Lo$ : minimum value, $Hi$ : maximum value is displayed.)	$nonE$
$Un$ $it$	Measurement value. (Desired measurement value for unit selection).	$nonE$
$CRlt$	Calibration type. ( $S.inP$ : Standard input type, $U.inP$ : User defined input type selection).	$S.inP$
$dPnt$	Decimal point selection. (Adjustable between the 1th. and 3rd digits).	0
$LSCL$	Lower scale value. (Adjustable between -1999 and $HSCL$ value).	0
$HSCL$	Upper scale value. (Adjustable between $LSCL$ and 4000 value).	2000

### OUTPUT CONTROL PARAMETERS

Parameter	Description	Initial Value
$oSEt$	Output set value. (Adjustable between $LSCL$ and $HSCL$ ).	2000
$oHYS$	Output hysteresis value. (Adjustable between 1 and 200).	2
$oSR$	Output status. ( $oFF$ : Output not active, $Lo$ : Becomes active below the setpoint output value, $Hi$ : Becomes active above the setpoint output value).	$oFF$
$oPon$	Required relay-on delay time in order to set output to active state after power-up. (Adjustable between 0 and 99 minutes).	0 1:00
$oTon$	Output relay-on delay time. (Adjustable between 0 and 99 minutes).	0 1:00
$oToF$	Output relay-off delay time. (Adjustable between 0 and 99 minutes).	0 1:00

ALARM CONTROL PARAMETERS		Initial Value
<i>RSEt</i>	Alarm set value. (Adjustable between <i>LSCl</i> and <i>HSCl</i> ).	<i>2000</i>
<i>RHYs</i>	Alarm hysteresis value. (Adjustable between <i>1</i> and <i>200</i> ).	<i>2</i>
<i>RtYP</i>	Alarm type. ( <i>indE</i> : Independent alarm, <i>dE</i> : Deviation alarm, <i>bRnd</i> : Band alarm)	<i>indE</i>
<i>RStR</i>	Alarm condition. ( <i>oFF</i> :Alarm not active. For independent or deviation alarm, <i>Lo</i> : Alarm is active below the set value, <i>Hi</i> : Alarm is active above the set value. For band alarm, <i>bHi</i> : Activated in "in-band", <i>boH</i> : Activated in "out-band".)	<i>oFF</i>
<i>RPon</i>	Required relay-on delay time in order to set alarm output to active state after power-up. (Adjustable between 0 and 99 minutes).	<i>0 1:00</i>
<i>Rton</i>	Alarm output relay-on delay time. (Adjustable between 0 and 99 minutes).	<i>0 1:00</i>
<i>RtoF</i>	Alarm output relay-off delay time. (Adjustable between 0 and 99 minutes).	<i>0 1:00</i>
RS485 MODBUS COMMUNICATION PARAMETERS		Initial Value
<i>RdS</i>	Slave device address. (Adjustable between <i>1</i> and <i>247</i> )	<i>1</i>
<i>bRUD</i>	Baudrate. (Can be adjusted as ; <i>oFF</i> , <i>1200</i> , <i>2400</i> , <i>4800</i> , <i>9600</i> , <i>19200</i> kbps)	<i>9600</i>

## MODBUS ADDRESS MAP

### HOLDING REGISTERS

Holding Register Addresses		Data Type	Data Content	Parameter Name	Read / Write Permission
Decimal	Hex				
0000d	0x0000	word	Input type selection. 0=0-20;1=4-20;2=0-1;3=0-10	<i>tyP</i>	R W
0001d	0x0001	word	Measurement ranges. 0=FRSt;1=5Lo1;2=5Lo2;3=5Lo3	<i>rRE</i>	R W
0002d	0x0002	word	Indicator locking parameter. 0=nonE;1=Lo;2=H	<i>hold</i>	R W
0003d	0x0003	word	Decimal point. 0=x;1=x.x;2=x.xx;3=x.xxx	<i>dPnt</i>	R W
0004d	0x0004	word	Scale lower value.	<i>LSCL</i>	R W
0005d	0x0005	word	Scale upper value.	<i>HSCL</i>	R W
0006d	0x0006	word	Output set value.	<i>oSEt</i>	R W
0007d	0x0007	word	Output hysteresis value.	<i>oHYS</i>	R W
0008d	0x0008	word	Output condition. (0=OFF,1=Lo, 2=H)	<i>oStR</i>	R W
0009d	0x0009	word	Required relay-on delay time in order to set output to active state after power-up.	<i>oPon</i>	R W
0010d	0x000A	word	Output relay-on delay time.	<i>oTon</i>	R W
0011d	0x000B	word	Output relay-off delay time.	<i>oToF</i>	R W
0012d	0x000C	word	Alarm set value.	<i>RSSEt</i>	R W
0013d	0x000D	word	Alarm hysteresis value.	<i>RSHYS</i>	R W
0014d	0x000E	word	Alarm type. 0= indE;1=dE;2=bRNd	<i>RtYP</i>	R W
0015d	0x000F	word	Alarm condition. 0=OFF, 1=Lo;1=H1;2=b1H1;3=boH1	<i>RStR</i>	R W
0016d	0x0010	word	Required relay-on delay time in order to set alarm output to active state after power-up.	<i>RPon</i>	R W
0017d	0x0011	word	Alarm output relay-on delay time.	<i>RToN</i>	R W
0018d	0x0012	word	Alarm output relay-off delay time.	<i>RToF</i>	R W

### INPUT REGISTERS

Holding Register Addresses		Data Type	Data Content	Parameter Name	Read / Write Permission
Decimal	Hex				
0000d	0x0000	word	Measured value	-	Read Only
0001d	0x0001	word	Minimum measured value	-	Read Only
0002d	0x0002	word	Maximum measured value	-	Read Only

\* Holding and Input Register parameters, which in integer type is defined as signed integer. Timing parameters are defined as seconds. (For example, 01:15 is defined as 75 seconds).

### DISCRATE INPUTS

Holding Register Addresses		Data Type	Data Content	Parameter Name	Read / Write Permission
Decimal	Hex				
0000d	0x0000	bit	OUT Control output condition. (0=OFF; 1=ON).	-	Read Only
0001d	0x0001	bit	Alarm control output condition. (0=OFF; 1=ON).	-	Read Only

### COILS

Coil Addresses		Data Type	Data Content	Parameter Name	Read / Write Permission
Decimal	Hex				
0000d	0x0000	bit	Indicator configuration oFF=PrCS, ON=PrUn	<i>dSPC</i>	R W
0001d	0x0001	bit	Calibration type oFF=SinP, ON=U.inP	<i>CRlt</i>	R W

### \* MODBUS CONNECTION DIAGRAM

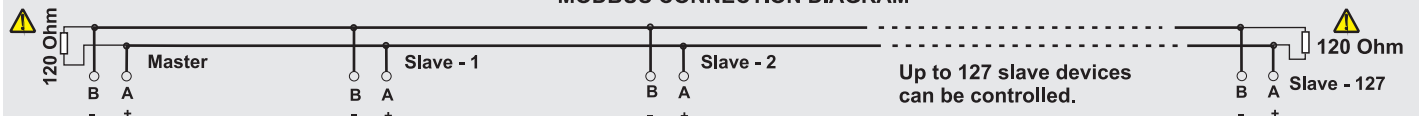

**!** Termination should be accomplished by attaching 120 Ohm resistors to the start and at the end of the communication line.

\* Applies to devices with Modbus function.