



Read this document carefully before using this device. The guarantee will be expired by damaging of the device if you don't attend to the directions in the user manual. Also we don't accept any compensations for personal injury, material damage or capital disadvantages.

ENDA ET1121 (MASTER) DIN RAIL MOUNTING PID UNIVERSAL STEP CONTROLLER

Thank you for choosing ENDA ET1121 PID universal step controller.

- * DIN rail mounting box.
- * Selectable dual-set value.
- * Selectable sensor type.
- * Selectable 0-20mA or 4-20mA input.
- * Automatic calculation of PID parameters (SELF TUNE).
 - ⚠ Selftune for automatic PID calculation or manually enter PID parameters if known.
- * Control outputs can be cancelled. (To use for measurement purposes).
- * Possible to control C/A2 or ANL/SSR outputs manually.
- * Soft-Start.
- * Communication via RS-485 ModBus protocol.
- * Selectable analog, SSR or relay control output.
- * Selectable 0-20mA or 4-20mA analog control output.
- * C/A2 Relay output can be programmed as secondary alarm or control output.
- * A1 relay output can be programmed as PID cooling primary alarm output.
- * Selectable Heating/Cooling control.
- * Offset feature for input.
- * In the case of sensor failure, periodical running or relay state selection.
- * Programmable via ModBus.
- * Profile control up to 16 steps.
- * On-demand relay output at profile steps.
- * Timer and thermostat feature can be used in profile control mode.
- * Up to 7 slave devices can be connected simultaneously.
- * CE marked according to European Norms.

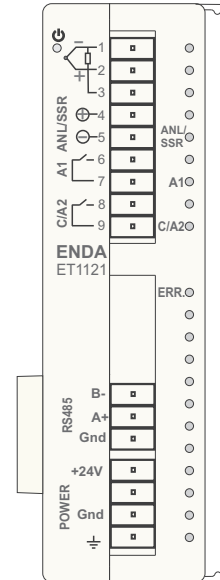

RoHS
Compliant

TECHNICAL SPECIFICATIONS

Input type	Temperature range		Accuracy
	°C	°F	
PT100 Resistance Thermometer EN 60751	-200...600 °C	-328... +1112°F	± 0,2% (of full scale) ± 1 digit
PT100 Resistance Thermometer EN 60751	-99.9...300.0 °C	-99.9...+543.0°F	± 0,2% (of full scale) ± 1 digit
J (Fe-CuNi) Thermocouple EN 60584	0... 600°C	+32... +1112°F	± 0,2% (of full scale) ± 1 digit
K (NiCr-Ni) Thermocouple EN 60584	-200...1300°C	+32... +2192°F	± 0,2% (of full scale) ± 1 digit
T (Cu-CuNi) Thermocouple EN 60584	-200... 400°C	+32... +752°F	± 0,2% (of full scale) ± 1 digit
S (Pt/0Rh-Pt) Thermocouple EN 60584	0...1700°C	+32... +2912°F	± 0,2% (of full scale) ± 1 digit
R (Pt13Rh-Pt) Thermocouple EN 60584	0...1700°C	+32... +2912°F	± 0,2% (of full scale) ± 1 digit
0-20 mA EN 60584	-999...4000		± 0,2% (of full scale) ± 1 digit
4-20 mA EN 60584	-999...4000		± 0,2% (of full scale) ± 1 digit

ENVIRONMENTAL CONDITIONS

Ambient/storage temperature	0 ... +50°C/-25... +70°C (with no icing)		
Max. Relative humidity	80% Relative humidity for temperatures up to 31°C, decreasing linearly to 50% at 40°C.		
Protection rating	According to EN 60529	Front panel : IP65	Rear panel : IP20
Height	Max. 2000m		



Do not use the device in locations subject to corrosive and flammable gases.

ELECTRICAL CHARACTERISTICS

Supply	24V DC ±%20
Power consumption	Max. 5VA
Wiring	1.5mm² screw-terminal connections
Line resistance	For thermocouple max.100ohm, for 3 wired PT100 max. 20ohm
Data retention	EEPROM (minimum 10 years)
EMC	EN 61326-1: 2006 (Performance criterion B for standard EN 61000-4-3)
Safety requirements	EN 61010-1: 2010 (Pollution degree 2, overvoltage category II)

OUTPUTS

C/A2	Relay : 250V AC, 2A (for resistive load), NO/NC. Selectable as Control or Alarm2 output.
AL1	Relay : 250V AC, 2A (for resistive load), NO/NC selectable. (Alarm1 output).
ANL/SSR	Selectable as 0-20mA, 4-20mA analog output or logic control output.
Life expectancy for relay	Mechanical 30.000.000 operation; Electrical 300.000 operation

CONTROL

Control type	Single set-point and alarm control
Control algorithm	On-Off / P, PI, PD, PID (selectable)
A/D converter	15 bits
Sampling time	100ms (minimum)
Proportional band	Adjustable between 0% and 100%. If Pb=0%, On-Off control is selected.
Integral time	Adjustable between 0.0 and 100.0 minutes
Derivative time	Adjustable between 0.00 and 25.00 minutes
Control period	Adjustable between 1 and 250 seconds
Hysteresis	Adjustable between 1 and 50°C/F
Output power	The ratio of power at a set point can be adjusted between 0% and 100%

HOUSING

Housing type	Rail - mounted box according to DIN 43 700.
Dimensions	W25,5xH91xD65mm
Weight	Approx. 200g (after packing)
Enclosure material	Self extinguishing plastics used.



While cleaning the device, solvents (thinner, benzene, acid etc.) or corrosive materials must not be used.

ALARM1 AND ALARM2 OUTPUT TYPES (Diagrams are arranged for Alarm1)

Figure 1

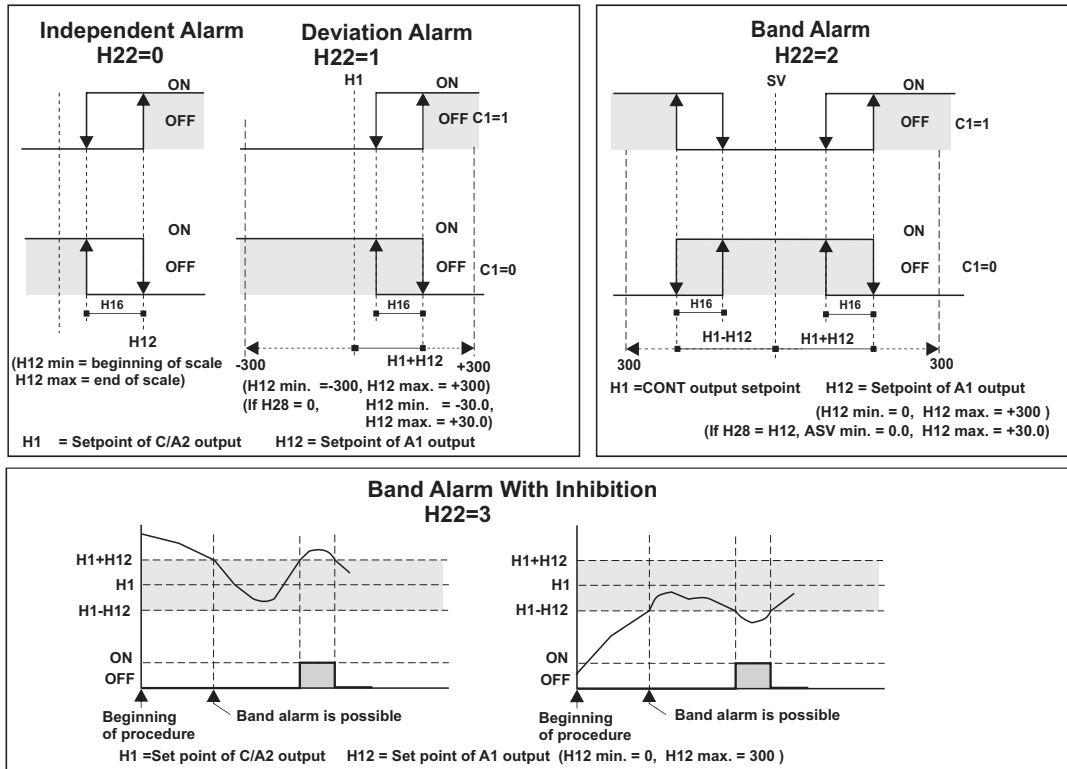

CONNECTION DIAGRAM



ENDA ET1121 and ET1111 are intended for installation in control panels. Make sure that the device is used only for intended purpose. The shielding must be grounded on the instrument side. During an installation, all of the cables that are connected to the device must be free of electrical power. The device must be protected against inadmissible humidity, vibrations, severe soiling and make sure that the operation temperature is not exceeded. All input and output lines that are not connected to the supply network must be laid out as shielded and twisted cables. These cables should not be close to the power cables or components. The installation and electrical connections must be carried on by a qualified staff and must be according to the relevant locally applicable regulations.

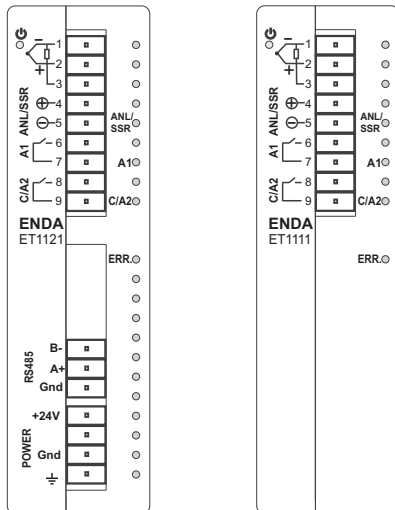

Logic output of the instrument is not electrically insulated from the internal circuits. Therefore, when using a grounding thermocouple, do not connect the logic output terminals to the ground.

- Note :**
- 1) Mains supply cords shall meet the requirements of IEC 60227 or IEC 60245.
 - 2) In accordance with the safety regulations, the power supply switch shall bring the identification of the relevant instrument and it should be easily accessible by the operator.



Holding screw
0.4-0.5Nm



Equipment is protected throughout
by DOUBLE INSULATION.

RoHS
Compliant

**Order Code : ET1121 (Master)
ET1111 (Slave)**

NOTE :

For J-K-T-S-R type thermocouple :
Use suitable compensation cables. Don't use jointed cables. Pay attention to the polarities of the thermocouple cables as shown in the figure right are connected to the .

For resistance thermometer:
When 2 wired PT100 is used, terminals 2 and 3 must be short circuited.

For 0-20mA ve 4-20mA input :
mA sensor output signals, making sure to connect the input of the device.

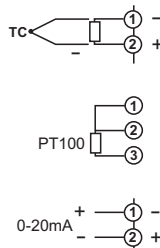

NOTE :

SUPPLY :

21.6-26.4V DC
1A

SENSOR INPUT :

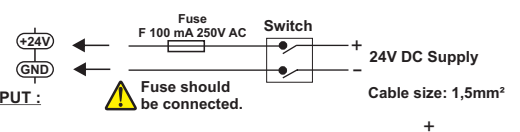

TIMER / THERMOSTAT OUTPUT SAMPLES

Figure 2

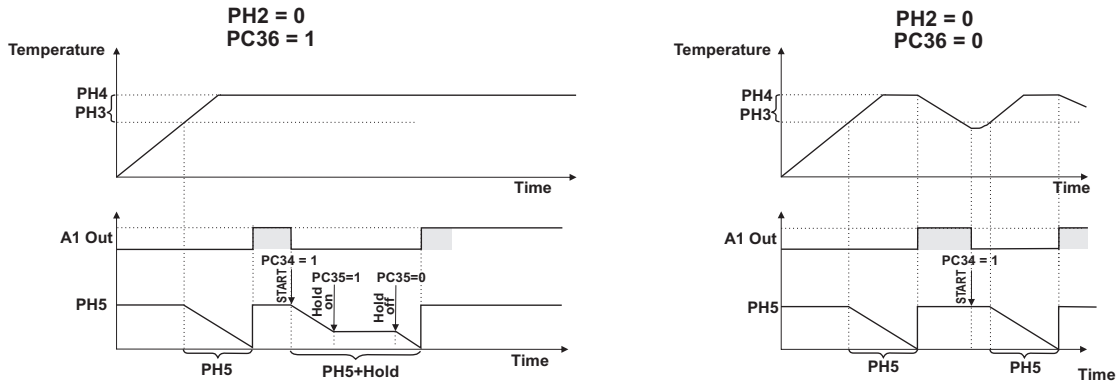

PROFILE CONTROL OUTPUT SAMPLES

Figure 3

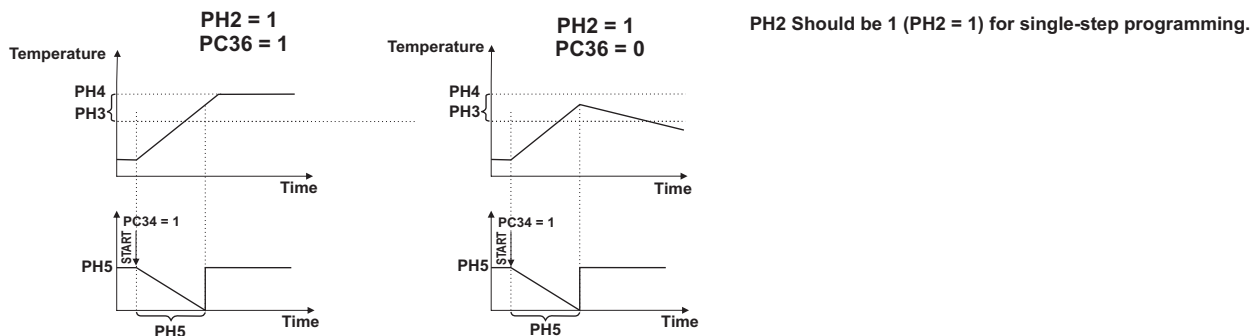

MULTI-STEP PROFILE CONTROL OUTPUT SAMPLES

Figure 4

	Step1	Step2	Step3	Step4	Step5
Target Temp.	PH4 = 100	PH6 = 100	PH8 = 300	PH10 = 300	PH12 = 100
Time	PH5 = 30	PH7 = 20	PH9 = 60	PH11 = 40	PH13 = 60
A1 Output	PC1 = 1	PC2 = 0	PC3 = 0	PC4 = 1	PC5 = 0
C/A2 Output	PC17 = 0	PC18 = 1	PC19 = 0	PC20 = 1	PC21 = 0

PH2 Should be 5 (PH2 = 5) for five-step programming.

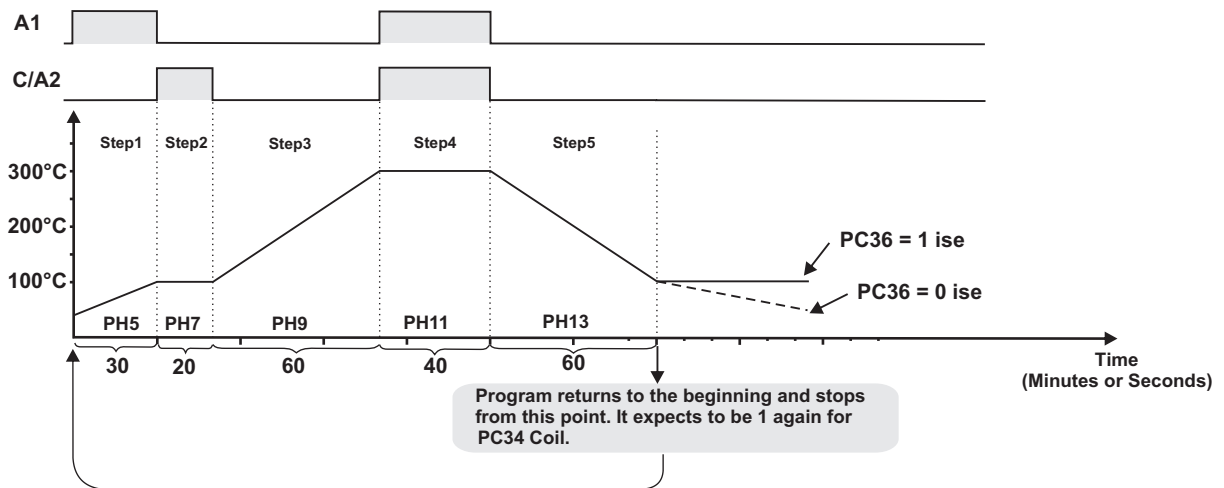

ENDA ET1121 (MASTER) and ET1111 (SLAVE) RAIL MOUNTABLE PID UNIVERSAL STEP CONTROLLER MODBUS ADDRESS MAP

1.1 Memory Map for Thermostat Holding Registers

	Parameter Number	Holding Register addresses Decimal (Hex)	Data type	Data content	Read /write permission	Factory defaults																															
Control Output Parameters	H1	0000d (0000h)	Word	Control output set value of the temperature	Readable / Writable	400																															
	H40	0039d (0027h)	Word	Control output the second temperature set value	Readable / Writable	400																															
	H41	0040d (0028h)	Word	Manual output percent value (Adjustable between 0%-100.)	Readable / Writable	0																															
	H2	0001d (0001h)	Word	Control output minimum set value limit	Readable / Writable	0																															
	H3	0002d (0002h)	Word	Control output maximum set value limit	Readable / Writable	600																															
	H4	0003d (0003h)	Word	Control output proportional band set value (Adjustable between 0% - 100%)	Readable / Writable	4.0																															
	H5	0004d (0004h)	Word	Control output hysteresis value (Adjustable 1 - 50 °C/°F)	Readable / Writable	2																															
	H6	0005d (0005h)	Word	Control output integral time value (Adjustable between 0.1 - 100.0 min.)	Readable / Writable	4.0																															
	H7	0006d (0006h)	Word	Control output derivative time (Adjustable between 0.01 - 10.00 min.)	Readable / Writable	100																															
	H8	0007d (0007h)	Word	Control output period time set value (Adjustable between 1 - 250 sec.)	Readable / Writable	20																															
	H9	0008d (0008h)	Word	Control output set value's is energy value (Adjustable between 0%-100%.)	Readable / Writable	0																															
A1 Output Parameters	H10	0009d (0009h)	Word	% Value for output during a sensor failure (Adjustable between 0% - 100%)	Readable / Writable	0																															
	H11	0010d (000Ah)	Word	Control output Soft start timer set value	Readable / Writable	0																															
	H12	0011d (000Bh)	Word	Alarm1 output temperature set value	Readable / Writable	500																															
	H13	0012d (000Ch)	Word	Alarm1 output minimum set value limit	Readable / Writable	0																															
	H14	0013d (000Dh)	Word	Alarm1 output maximum set value limit	Readable / Writable	600																															
	H15	0014d (000Eh)	Word	Alarm1 output proportional band set value (Adjustable between 0 % - 100 %)	Readable / Writable	0																															
	H16	0015d (000Fh)	Word	Hysteresis value of the Alarm1 output (Adjustable between 1 - 50 °C/°F)	Readable / Writable	2																															
	H17	0016d (0010h)	Word	Integral time value of the Alarm1 output (Adjustable between 0.1 - 100.0 min)	Readable / Writable	0																															
	H18	0017d (0011h)	Word	Derivative time value of the Alarm1 output (Adjustable between 0.01 - 10.00 min.)	Readable / Writable	0																															
	H19	0018d (0012h)	Word	Period time value of the Alarm1 output (Adjustable between 1 - 250 sec.)	Readable / Writable	20																															
	H20	0019d (0013h)	Word	Alarm1 output set value's energy value (Adjustable between 0%-100%.)	Readable / Writable	0																															
A2 Output Parameters	H21	0021d (0014h)	Word	On the sensor failure situation value of energy percent Alarm1 (Adjustable between 0%-100% .)	Readable / Writable	0																															
	H22	0021d (0015h)	Word	Alarm1 output type selection (Given values of 0 and 4) (0 = Independent alarm, 1 = Deviation alarm, 2 = Band alarm, 3 = After entering into the band,active alarm 4 = Alarm1 output cooling control selection, 5 = Dependent on the cooling temperature setpoint control of output Alarm1)	Readable / Writable	0																															
	H23	0022d (0016h)	Word	Alarm2 output temperature set value	Readable / Writable	500																															
	H24	0023d (0017h)	Word	Alarm2 output minimum set value limit	Readable / Writable	0																															
	H25	0024d (0018h)	Word	Alarm2 output maximum set value limit	Readable / Writable	600																															
	H26	0025d (0019h)	Word	Hysteresis value of the Alarm1 output (Adjustable between 1 and 50 °C/°F)	Readable / Writable	2																															
	H27	0026d (001Ah)	Word	Alarm2 output type selection (Given values of 0 and 3) (0 = Independent alarm, 1 = Deviation alarm, 2 = Band alarm, 3 = After entering into the band,active alarm)	Readable / Writable	0																															
	Configuration Parameters	H28	0027d (001Bh)	Word	Input selection number (0 = PT100 decimal, 1 = PT100 without decimal, 2 = J, 3 = K, 4 = T, 5 = S, 6 = R, 7 = 0-20mA, 8 = 4-20mA	Readable / Writable	1																														
		H29	0028d (001Ch)	Word	For ModBus device address value (Adjustable between 1-247.) (Only valid for master)	Readable / Writable	3																														
		H30	0029d (001Dh)	Word	For ModBus communication rate (0 =Modbus cancel,1 = 2400 bps, 2 = 4800 bps,3 = 9600 bps 4 =19200 bps,5 = 38400 bps (Only valid for master))	Readable / Writable	0																														
		H31	0030d (001Eh)	Word	For 0-20mA and 4-20mA inputs decimal point set value (Adjustable between 0 - 3)	Readable / Writable	5																														
H32		0031d (001Fh)	Word	Digital filter coefficient (Adjustable between 1-32.If digital filter coefficient is 1,digital filter disabled)	Readable / Writable	0																															
H33		0032d (0020h)	Word	Control output selection value (0 = C/A2 control output, 1 = SSR/ANL output, SSR output 2 = SSR/ANL output 0-20mA output, 3 = SSR/ANL output 4-20mA output	Readable / Writable	0																															
H34		0033d (0021h)	Word	The minimum percentage of output value	Readable / Writable	0																															
H35		0034d (0022h)	Word	The maximum percentage of output value	Readable / Writable	100																															
H36		0035d (0023h)	Word	Offset value	Readable / Writable	0																															
H37		0036d (0024h)	Word	For 0-20mA and 4-20mA input selections user lower scale value	Readable / Writable	-999																															
H38		0037d (0025h)	Word	For 0-20mA and 4-20mA input selections user upper scale value	Readable / Writable	3000																															
Configuration Parameters	H39	0038d (0026h)	Word	Function control parameter (If 23040d (5A00h) value is entered, self tune is stopped.) (If 23041d (5A01h) value is entered, self tune is started.) (If 23042d (5A02h) value is entered, H1...H42 and C1...C9 parameters returns to the factory defaults.) (If 23043d (5A03h) value is entered, PH1...PH38 and PC1...PC39 parameters returns to the factory defaults.)	Readable / Writable	0																															
	H42	0041d (0029h)	Word	Configuration registers (Holding registers for C1 - C9 configuration coils). <table border="1" style="margin: 5px auto; border-collapse: collapse;"> <tr> <td>B15</td><td>B14</td><td>B13</td><td>B12</td><td>B11</td><td>B10</td><td>B9</td><td>B8</td><td>B7</td><td>B6</td><td>B5</td><td>B4</td><td>B3</td><td>B2</td><td>B1</td><td>B0</td> </tr> <tr> <td>C8</td><td>C7</td><td>C6</td><td>C5</td><td>C4</td><td>C3</td><td>C2</td><td>C1</td><td>-</td><td>-</td><td>-</td><td>-</td><td>-</td><td>-</td><td>-</td><td>C9</td> </tr> </table> See instructions on chapter 1.3 coil descriptions for the meaning of bits	B15	B14	B13	B12	B11	B10	B9	B8	B7	B6	B5	B4	B3	B2	B1	B0	C8	C7	C6	C5	C4	C3	C2	C1	-	-	-	-	-	-	-	C9	Readable / Writable
B15	B14	B13	B12	B11	B10	B9	B8	B7	B6	B5	B4	B3	B2	B1	B0																						
C8	C7	C6	C5	C4	C3	C2	C1	-	-	-	-	-	-	-	C9																						

WARNING ! The Slave addresses to reach for; the slave number X 1000 (03E8H) offset is added.

EXAMPLE: Slave is the number 2, the filter coefficient value (numbered of H32 parameter) to read 2 x 1000 = 2000 offset, Filter coefficient by adding to the 31 2nd. Slave's Filter coefficient address is found as of 2031 (07EFH).

For 1st. slave this address is found as of (1 x 1000) + 31 = 1031 (0407H).

ENDA ET1121 (MASTER) and ET1111 (SLAVE) RAIL MOUNTABLE PID UNIVERSAL STEP CONTROLLER MODBUS ADDRESS MAP

1.2 Memory Map for Step Control Holding Registers

Parameter Number	Holding Register addresses Decimal (Hex)	Data Type	Data content	Read / Write Permission	Factory Defaults																																
PH1	0100d (0064h)	Word	Profile time base set value. (0 = 0000sec, 1 = 00m59sec, 2 = 0000min., 3 = 99m59sec)	Readable / Writable	0																																
PH2	0101d (0065h)	Word	Maximum number of steps (Adjustable between 0 and 16. If it is 0, in timer/thermostat mode).	Readable / Writable	0																																
PH3	0102d (0066h)	Word	Temperature differences of step end, can be set between 0 and H3 parameters. (During in profile control, when the target temperature is reached, step time runs out, the differences between the target temperature, the measured temperature is equal to or less than the value of this parameter is pending, so the next step is started. If PH2 = 0, the difference between the target temperature and the measured value is less than or equal to this parameter, the timer runs. Please see Figure 2).	Readable / Writable	0																																
PH4	0103d (0067h)	Word	1st. Step, set value of target temperature (Parameter set between H2 and H3)	Readable / Writable	200																																
PH5	0104d (0068h)	Word	1st. Step, time value (In BCD format can be set between 0 and 99m 59s (varies according to H42 parameter))	Readable / Writable	0																																
PH6	0105d (0069h)	Word	2nd. Step, set value of target temperature (Parameter set between H2 and H3)	Readable / Writable	200																																
PH7	0106d (006Ah)	Word	2nd. Step, time value (In BCD format can be set between 0 and 99m 59s (varies according to H42 parameter))	Readable / Writable	0																																
PH8	0107d (006Bh)	Word	3rd. Step, set value of target temperature (Parameter set between H2 and H3)	Readable / Writable	200																																
PH9	0108d (006Ch)	Word	3rd. Step, time value (In BCD format can be set between 0 and 99m 59s (varies according to H42 parameter))	Readable / Writable	0																																
PH10	0109d (006Dh)	Word	4th. Step, set value of target temperature (Parameter set between H2 and H3)	Readable / Writable	200																																
PH11	0110d (006Eh)	Word	4th. Step, time value (In BCD format can be set between 0 and 99m 59s (varies according to H42 parameter))	Readable / Writable	0																																
PH12	0111d (006Fh)	Word	5th. Step, set value of target temperature (Parameter set between H2 and H3)	Readable / Writable	200																																
PH13	0112d (0070h)	Word	5th. Step, time value (In BCD format can be set between 0 and 99m 59s (varies according to H42 parameter))	Readable / Writable	0																																
PH14	0113d (0071h)	Word	6th. Step, set value of target temperature (Parameter set between H2 and H3)	Readable / Writable	200																																
PH15	0114d (0072h)	Word	6th. Step, time value (In BCD format can be set between 0 and 99m 59s (varies according to H42 parameter))	Readable / Writable	0																																
PH16	0115d (0073h)	Word	7th. Step, set value of target temperature (Parameter set between H2 and H3)	Readable / Writable	200																																
PH17	0116d (0074h)	Word	7th. Step, time value (In BCD format can be set between 0 and 99m 59s (varies according to H42 parameter))	Readable / Writable	0																																
PH18	0117d (0075h)	Word	8th. Step, set value of target temperature (Parameter set between H2 and H3)	Readable / Writable	200																																
PH19	0118d (0076h)	Word	8th. Step, time value (In BCD format can be set between 0 and 99m 59s (varies according to H42 parameter))	Readable / Writable	0																																
PH20	0119d (0077h)	Word	9th. Step, set value of target temperature (Parameter set between H2 and H3)	Readable / Writable	200																																
PH21	0120d (0078h)	Word	9th. Step, time value (In BCD format can be set between 0 and 99m 59s (varies according to H42 parameter))	Readable / Writable	0																																
PH22	0121d (0079h)	Word	10th. Step, set value of target temperature (Parameter set between H2 and H3)	Readable / Writable	200																																
PH23	0122d (007Ah)	Word	10th. Step, time value (In BCD format can be set between 0 and 99m 59s (varies according to H42 parameter))	Readable / Writable	0																																
PH24	0123d (007Bh)	Word	11th. Step, set value of target temperature (Parameter set between H2 and H3)	Readable / Writable	200																																
PH25	0124d (007Ch)	Word	11th. Step, time value (In BCD format can be set between 0 and 99m 59s (varies according to H42 parameter))	Readable / Writable	0																																
PH26	0125d (007Dh)	Word	12th. Step, set value of target temperature (Parameter set between H2 and H3)	Readable / Writable	200																																
PH27	0126d (007Eh)	Word	12th. Step, time value (In BCD format can be set between 0 and 99m 59s (varies according to H42 parameter))	Readable / Writable	0																																
PH28	0127d (007Fh)	Word	13th. Step, set value of target temperature (Parameter set between H2 and H3)	Readable / Writable	200																																
PH29	0128d (0080h)	Word	13th. Step, time value (In BCD format can be set between 0 and 99m 59s (varies according to H42 parameter))	Readable / Writable	0																																
PH30	0129d (0081h)	Word	14th. Step, set value of target temperature (Parameter set between H2 and H3)	Readable / Writable	200																																
PH31	0130d (0082h)	Word	14th. Step, time value (In BCD format can be set between 0 and 99m 59s (varies according to H42 parameter))	Readable / Writable	0																																
PH32	0131d (0083h)	Word	15th. Step, set value of target temperature (Parameter set between H2 and H3)	Readable / Writable	200																																
PH33	0132d (0084h)	Word	15th. Step, time value (In BCD format can be set between 0 and 99m 59s (varies according to H42 parameter))	Readable / Writable	0																																
PH34	0133d (0085h)	Word	16th. Step, set value of target temperature (Parameter set between H2 and H3)	Readable / Writable	200																																
PH35	0134d (0086h)	Word	16th. Step, time value (In BCD format can be set between 0 and 99m 59s (varies according to H42 parameter))	Readable / Writable	0																																
PH36	0135d (0087h)	Word	AL1 output control bits in steps <div style="text-align: center;"> <table border="1" style="margin: auto;"> <tr> <td>B15</td><td>B14</td><td>B13</td><td>B12</td><td>B11</td><td>B10</td><td>B9</td><td>B8</td><td>B7</td><td>B6</td><td>B5</td><td>B4</td><td>B3</td><td>B2</td><td>B1</td><td>B0</td> </tr> <tr> <td>Seg8</td><td>Seg7</td><td>Seg6</td><td>Seg5</td><td>Seg4</td><td>Seg3</td><td>Seg2</td><td>Seg1</td><td>Seg16</td><td>Seg15</td><td>Seg14</td><td>Seg13</td><td>Seg12</td><td>Seg11</td><td>Seg10</td><td>Seg9</td> </tr> </table> </div> In the corresponding step by step set bits, AL1 output becomes active.	B15	B14	B13	B12	B11	B10	B9	B8	B7	B6	B5	B4	B3	B2	B1	B0	Seg8	Seg7	Seg6	Seg5	Seg4	Seg3	Seg2	Seg1	Seg16	Seg15	Seg14	Seg13	Seg12	Seg11	Seg10	Seg9	Readable / Writable	0
B15	B14	B13	B12	B11	B10	B9	B8	B7	B6	B5	B4	B3	B2	B1	B0																						
Seg8	Seg7	Seg6	Seg5	Seg4	Seg3	Seg2	Seg1	Seg16	Seg15	Seg14	Seg13	Seg12	Seg11	Seg10	Seg9																						
PH37	0136d (0088h)	Word	AL2 output control bits in steps (Set like PH36 parameter).	Readable / Writable	0																																
PH38	0137d (0089h)	Word	Step control parameter (Holding register of PC33-PC39 step control coils). <div style="text-align: center;"> <table border="1" style="margin: auto;"> <tr> <td>B15</td><td>B14</td><td>B13</td><td>B12</td><td>B11</td><td>B10</td><td>B9</td><td>B8</td><td>B7</td><td>B6</td><td>B5</td><td>B4</td><td>B3</td><td>B2</td><td>B1</td><td>B0</td> </tr> <tr> <td>—</td><td>PC39</td><td>PC38</td><td>PC37</td><td>PC36</td><td>PC35</td><td>PC34</td><td>PC33</td><td>—</td><td>—</td><td>—</td><td>—</td><td>—</td><td>—</td><td>—</td><td>—</td> </tr> </table> </div> Please see description in chapter 1.4 for the meaning of bits coil	B15	B14	B13	B12	B11	B10	B9	B8	B7	B6	B5	B4	B3	B2	B1	B0	—	PC39	PC38	PC37	PC36	PC35	PC34	PC33	—	—	—	—	—	—	—	—	Readable / Writable	0
B15	B14	B13	B12	B11	B10	B9	B8	B7	B6	B5	B4	B3	B2	B1	B0																						
—	PC39	PC38	PC37	PC36	PC35	PC34	PC33	—	—	—	—	—	—	—	—																						

WARNING ! The Slave addresses to reach for; the slave number X 1000 (03E8H) offset is added.
EXAMPLE: Slave is the number 3, the filter coefficient value (numbered of H42 parameter) to read 3 x 1000 = 3000 offset, Filter coefficient by adding to the 100 3rd. Slave's Filter coefficient address is found as of 3100 (0C1CH).
For 1st. slave this address is found as of (1 x 1000) + 100 = 1100 (044CH).

ENDA ET1121 (MASTER) and ET1111 (SLAVE) RAIL MOUNTABLE PID UNIVERSAL STEP CONTROLLER MODBUS ADDRESS MAP

1.3 Memory map for control Coils

Parameter Number	Coil Addresses	Data Type	Data content	Read / Write Permissions	Default Settings
C1	0000d (0000h)	Bit	State of Alarm2 (0 = Active Low ,1 =Active High)	Readable / Writable	1
C2	0001d (0001h)	Bit	State of Alarm2 in the case of sensor failure (0 = Low , 1 = High)	Readable / Writable	0
C3	0002d (0002h)	Bit	State of Alarm1 (0 = Active Low ,1 =Active High)	Readable / Writable	1
C4	0003d (0003h)	Bit	State of Alarm1 in the case of sensor failure (0 = Low , 1 = High)	Readable / Writable	0
C5	0004d (0004h)	Bit	Configuration of the control output (0 = Heating ; 1 = Cooling)	Readable / Writable	0
C6	0005d (0005h)	Bit	Temperature unit (0 = °C ; 1 = °F)	Readable / Writable	0
C7	0006d (0006h)	Bit	Control outputs active (0 = Control outputs active ; 1 = Works only as an indicator.)	Readable / Writable	1
C8	0007d (0007h)	Bit	According to the second set value control (If 0 = °C ; C8 =1, Temperature control is done according to the H1 and H40 parameters.)	Readable / Writable	0
C9	0008d (0008h)	Bit	Manual control enable bit. (If C9=0 automatic control, if C9=1; According to the manual output percent value on the H41 parameter; C/A2 output or ANL/SSR output.)	Readable / Writable	0

1.4 Memory map for step control Coils

Parameter Number	Coil Addresses Decimal (Hex)	Data Type	Data content	Read / Write Permissions	Default Settings
PC1-PC16	0100d (0064h) 0115d (0073h)	Bit	A1 alarm output programming coils at the profile steps. If PC = 1, A1 output is ON at first step. If PC16 = 1, A1 output is ON at 16th step.	Readable/ Writable	0
PC17-PC32	0116d (0074h) 0131d (0083h)	Bit	C/A2 alarm output programming coils at the profile steps. If PC17 = 1, C/A2 output is ON at first step. If PC32 = 1, C/A2 output is ON at 16th step.	Readable/ Writable	0
PC33	0132d (0084h)	Bit	If control method according setting value or selecting profile control, it is thermostad mode. If PC33 = 1, profile control mode.	Readable/ Writable	0
PC34	0133d (0085h)	Bit	Profile stops and return first step at profile mode when PC=34. If PC34 = 1, profile is not necessarily at profile mode.	Readable/ Writable	0
PC35	0134d (0086h)	Bit	If profile had be started profile goes on to work when PC=35. If PC35 = 1, profile at the point where work is suspended. (Hold mode).	Readable/ Writable	0
PC36	0135d (0087h)	Bit	If PC36 = 0 and when profile finhised, control progress is finhised.(control outputs OFF) If PC36 = 1, resume when the set point is controlled according to the profile	Readable/ Writable	0
PC37	0136d (0088h)	Bit	If PC37 = 0 and when energy cuts, profile is stopped after returned first step. If PC37 = 1, when the power is cut and given again, an also the temperature is in the setting value of available step, profile resumes on. If it is not return to the first step.	Readable/ Writable	0
PC38	0137d (0089h)	Bit	If PC38 = 0, A1 output is be controlled according H22 parameter. If PC38 = 1 and PC33 = 1, A1 output is be controlled according PH36 all of steps.	Readable/ Writable	0
PC39	0138d (008Ah)	Bit	If PC39 = 0, A2 output is be controlled according H27 parameter. If PC39 = 1 and PC33= 1, C/A2 output is be controlled according PH37 all of steps.	Readable/ Writable	0

1.5 Memory map for output status indicator bits

Parameter Number	Discrete input addresses	Data Type	Data content	Read / Write permissions
D1	(0000)h	Bit	C/A2 State of control output (0 = OFF , 1 = ON)	Only readable
D2	(0001)h	Bit	State of A1 output (0 = OFF , 1 = ON)	Only readable
D3	(0002)h	Bit	State of SSR output (0 = OFF , 1 = ON)	Only readable

1.6 Memory map for step control status indicators bits

Parameter Number	Discrete input addresses	Data Type	Data content	Read / Write permissions
PD1	0100d (0064h)	Bit	If D1 = 1, profile in constant temperature step.	Only readable
PD2	0101d (0065h)	Bit	If D2 = 1, profile in heating step.	Only readable
PD3	0102d (0066h)	Bit	If D3 = 1, profile in cooling step.	Only readable
PD4	0103d (0067h)	Bit	If D4 = 1, profile ended.	Only readable
PD5	0104d (0068h)	Bit	If D5 = 1, step timer 0.	Only readable
PD6	0105d (0069h)	Bit	If D6 = 1, step timer is running.	Only readable

1.7 Memory map for software revision input registers

Parameter Number	Discrete input addresses	Data Type	Data content	Read / Write permissions
Software revision	0808d (0328h)	14 Word	Software name and date of update in ASCII format and read as 14 word. Example: ET1121-01 09 Feb 2012. Memory format: Word Word Word Word Word Word Word Word Word Word Word Word Word Word Word Word 1 2 3 4 5 6 7 8 9 10 11 12 13 14 T E 1 1 1 2 0 - 1 9 0 F b e 2 1 0 . 2	Only readable
NOTE: To properly view; each word in the amended order showed apperar as ASCII text on the screen.				

WARNING ! The Slave addresses to reach for; the slave number X 1000 (03E8h) offset is added.
EXAMPLE: To read the value of the slave in the C1 coil number 3; 3 x 1000 = 3000 (0BB8h) offset, which is the address to 0 by adding coil C1 3th. (third) slave address in coil C1 3000 (0BB8h) is found.
 For the 1st (first) slave address (1 x 1000) + 0 = 1000 (03E8h) is found.

1.8 Memory map for Input Registers

Parameter Number	Input Register addressed Decimal (Hex)	Data type	Data content	Read /Write permission
I1	0000d (0000h)	Word	The measured temperature (decimal)	Only readable
I2	0001d (0001h)	Word	Analog output percent	Only readable
I3	0002d (0002h)	Word	Measurement error codes 0 = No error, 1 = Broken sensor error, 2 = Lower scale error, 3=Upper scale error,4=PT100 short circuit or very low temperature,5=input selection error	Only readable
				Only readable
I4	0003d (0003h)	Word	Self tune status codes 0 = No error, 1 = Initial temperature, set point higher than 60% 2 = PID parameters are calculating, 3 = Power set parameter is calculating	
		Word		
I5	0004d (0004h)		At Master,shows connected to the Master number of Slave, At Slave,show number of Slave.	Only readable
I6	0005d (0005h)	Word	Active temperature set value	Only readable

1.9 Memory map for step control input registers

Parameter Number	Discrete input addresses	Data Type	Data content	Read / Write permissions
PI1	0100d (0064h)	Bit	Parameter number of active step.	Only readable
PI2	0101d (0065h)	Bit	Remaining time indication of the active step.	Only readable
PI3	0102d (0066h)	Bit	Target temperature of the active step.	Only readable

WARNING ! The Slave addresses to reach for; the slave number X 1000 (03E8h) offset is added.

EXAMPLE: To read the value of the slave in the C1 coil number 3; $3 \times 1000 = 3000$ (0BB8h) offset, which is the address to 0 by adding coil C1 3th. (third) slave address in coil C1 3000 (0BB8h) is found.

For the 1st (first) slave address $(1 \times 1000) + 0 = 1000$ (03E8h) is found.



RETURN TO FACTORY SETTINGS

In case of communication can not be done or any other reason, may be needed to return to the hardware factory values. In this case, the PT100 input device is organized as follows. 1 and 2 inputs will be short circuited, connected to the 100ohm resistor 2 and 3 inputs then power up to the 1 seconds, the device shall be reverted to factory settings.

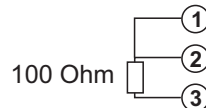

2. MODBUS ERROR MESSAGES

Modbus protocol has two types error, communication error and operating error. Reason of the communication error is data corruption in transmission. Parity and CRC control should be done to prevent communication error. Receiver side checks parity and CRC of the data. If they are wrong, the message will be ignored. If format of the data is true but function doesn't perform for any reason, operating error occurs. Slave realizes error and sends error message. Most significant bit of function is changed '1' to indicate error in error message by slave. Error code is sent in data section. Master realizes error type via this message.

ModBus Error Codes

Error Code	Name	Meaning
01	ILLEGAL FUNCTION	The function code received in the query is not an allowable action for the slave. If a Poll Program Complete command was issued, this code indicates that no program function preceded it.
02	ILLEGAL DATA ADDRESS	The data address received in the query is not an allowable address for the slave.
03	ILLEGAL DATA VALUE	A value contained in the query data field is not an allowable value for the slave.

Message example;

Structure of command message (Byte Format)

Device Address	(0A)h
Function Code	(01)h
Beginning address of coils.	MSB (04)h
	LSB (A1)h
Number of coils (N)	MSB (00)h
	LSB (01)h
CRC DATA	LSB (AC)h
	MSB (63)h

Structure of response message (Byte Format)

Device Address	(0A)h
Function Code	(81)h
Error Code	(02)h
CRC DATA	LSB (B0)h
	MSB (53)h